

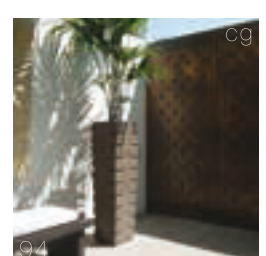

# NIKOJARDINS

Etude Création Entretien

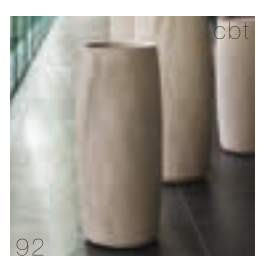

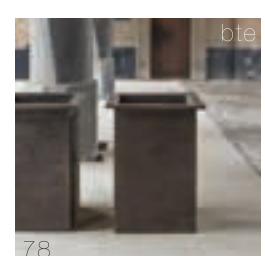
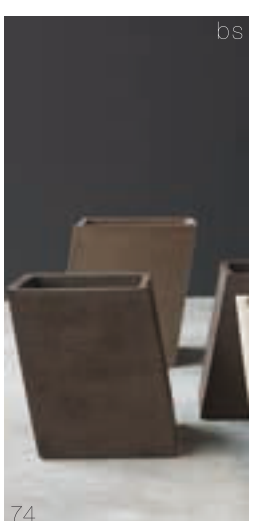
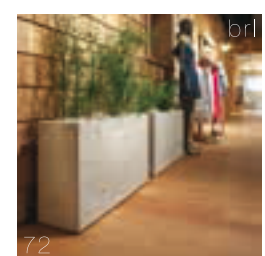
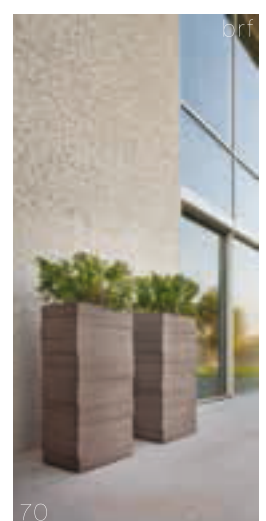
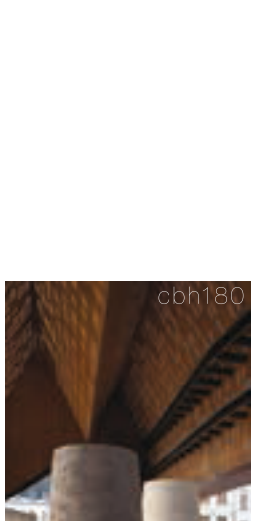
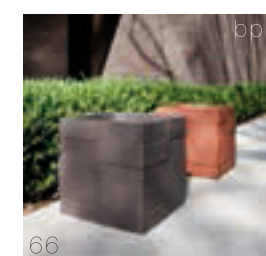
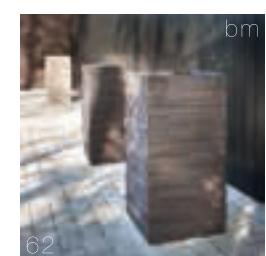
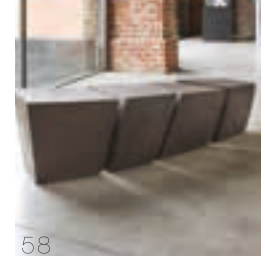
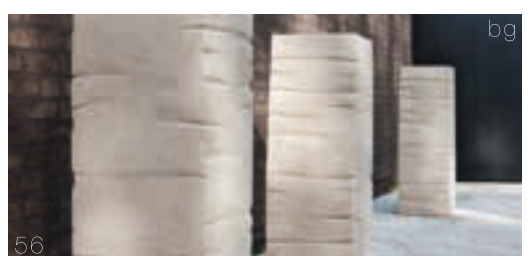
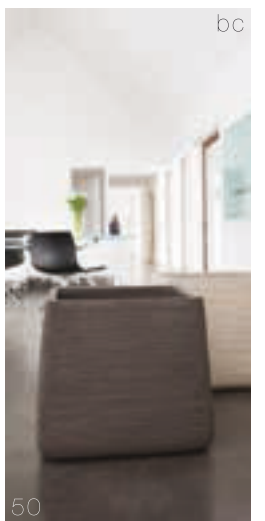
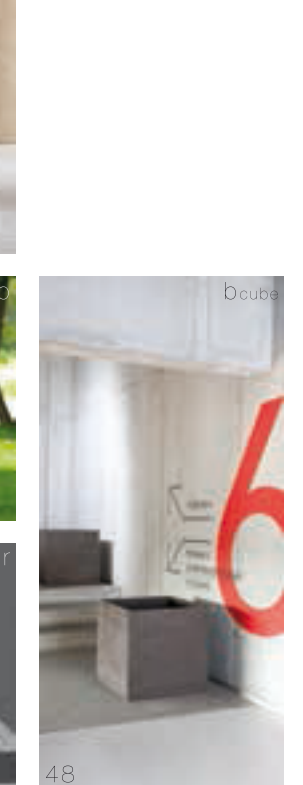
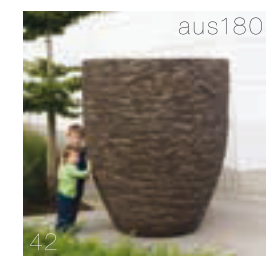
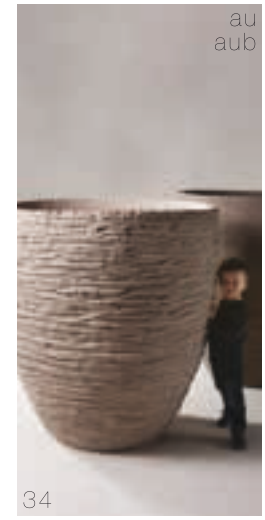
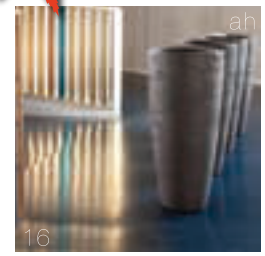
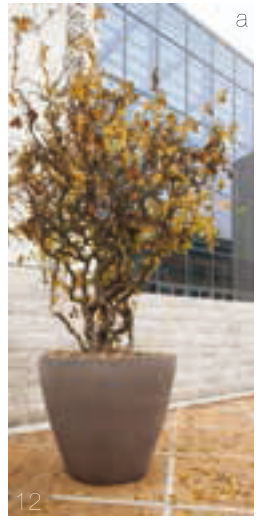
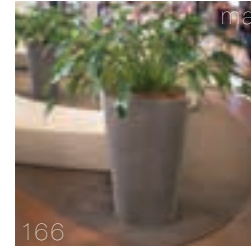
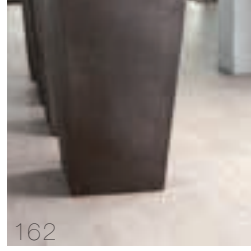
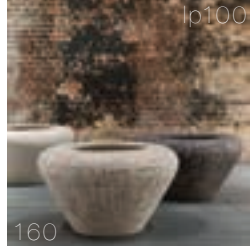
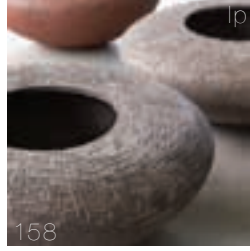
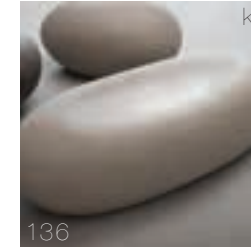
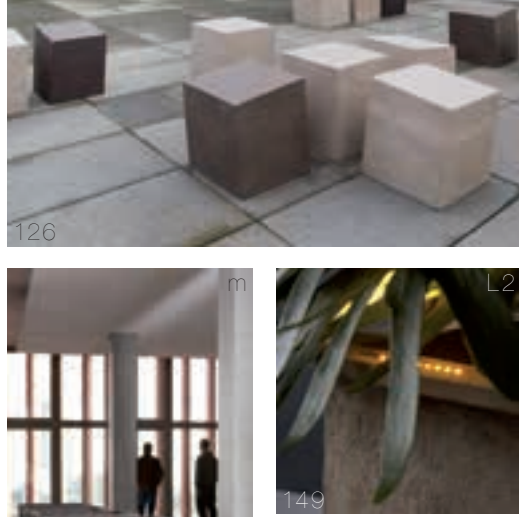
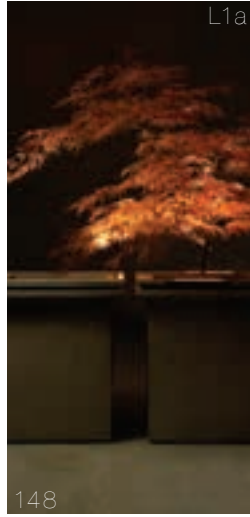
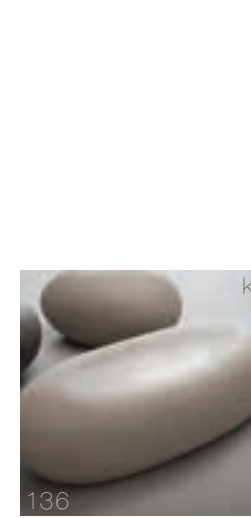
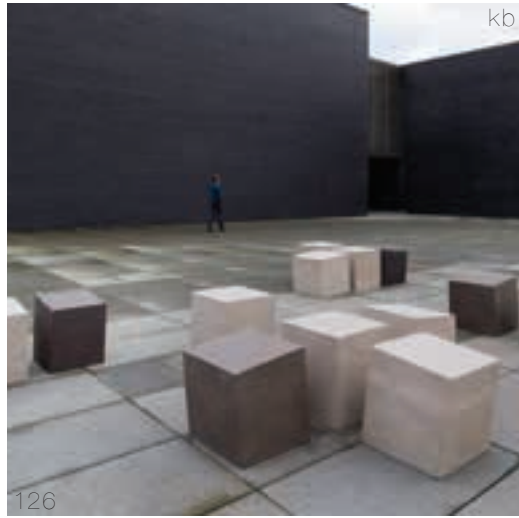
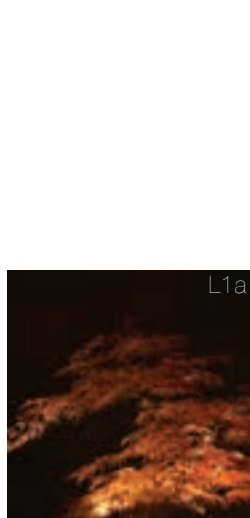
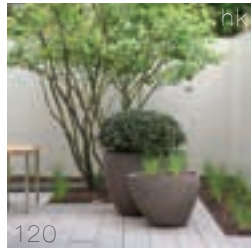
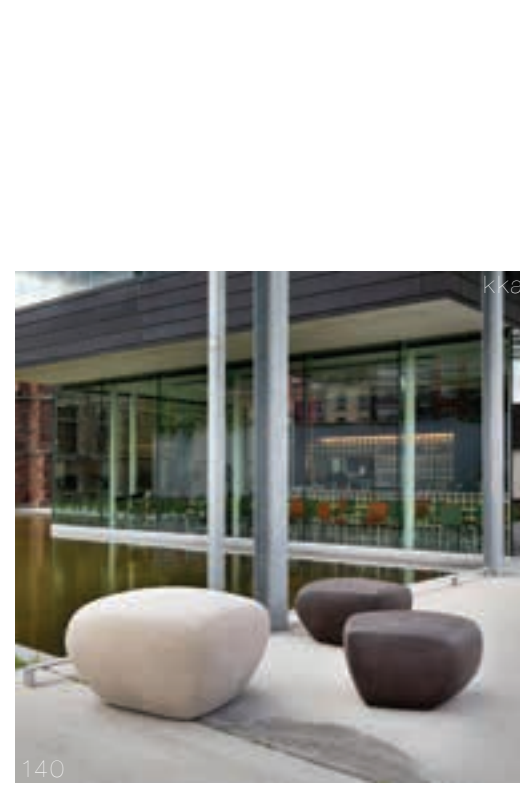
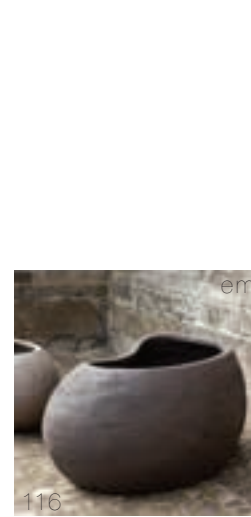
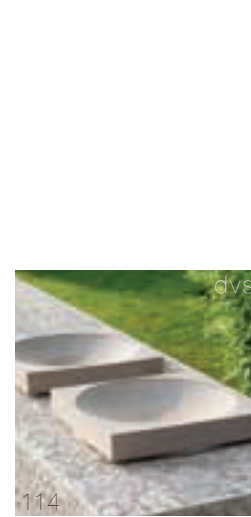
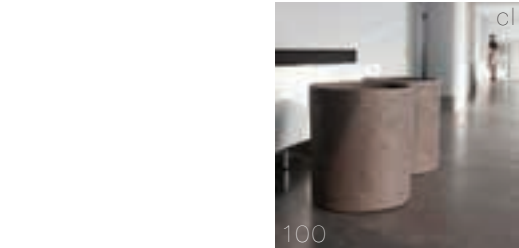

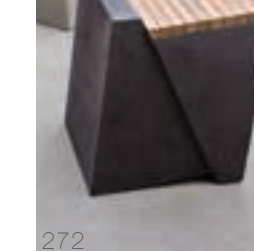
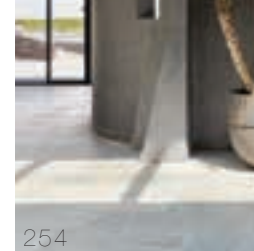
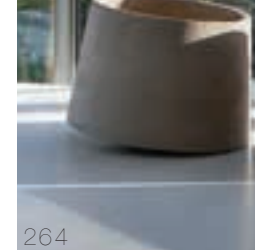
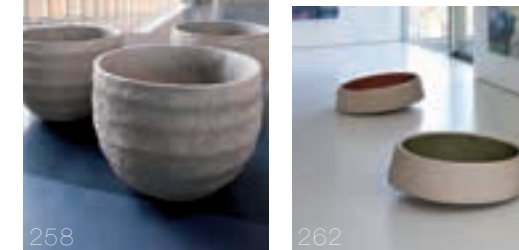
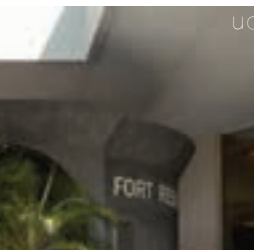
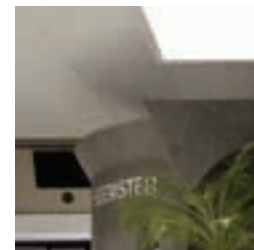
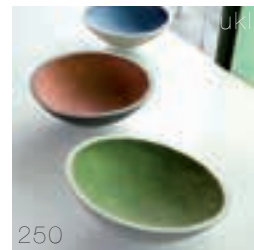
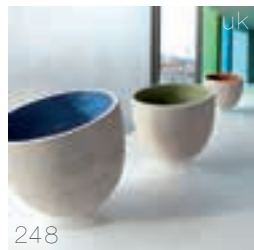
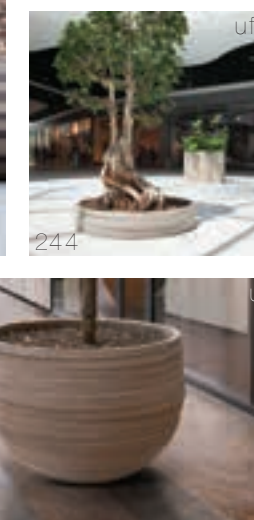
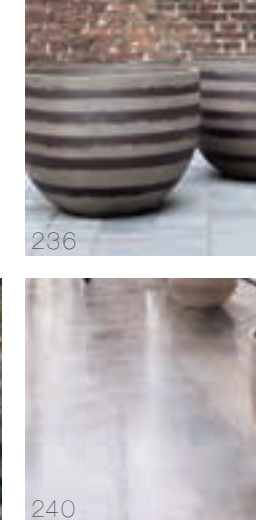
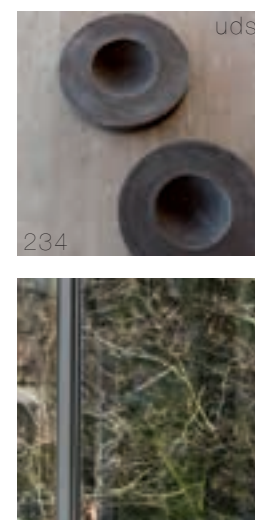
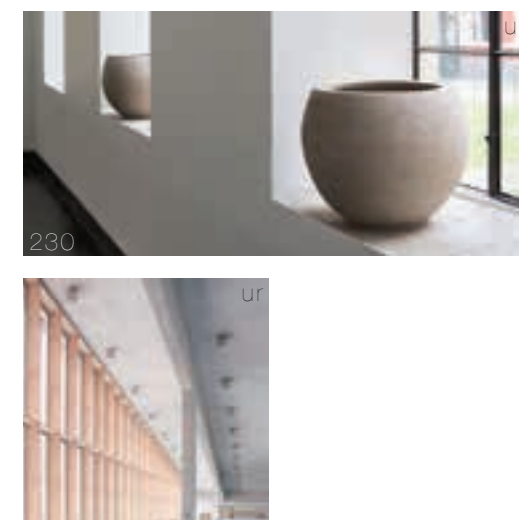
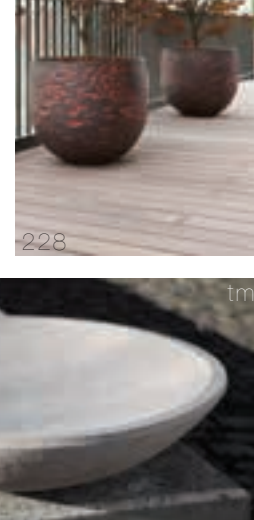
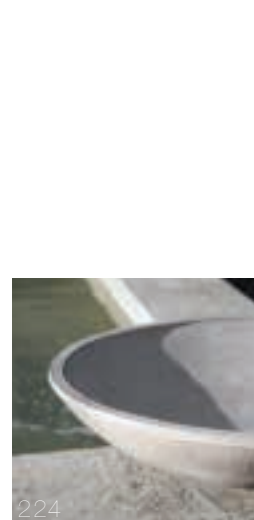
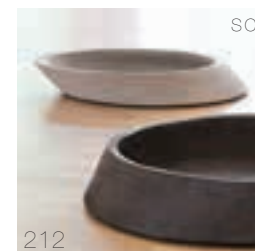
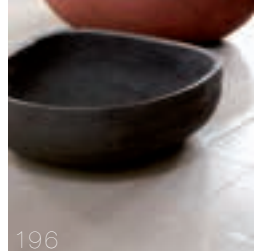
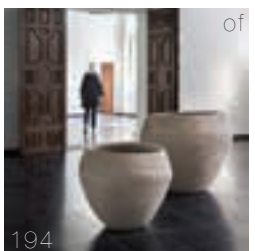
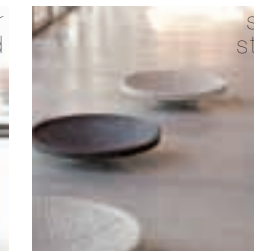
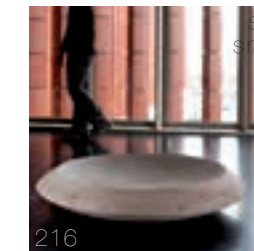
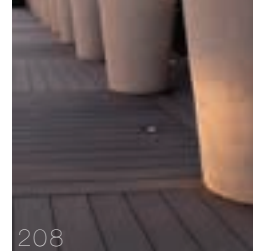
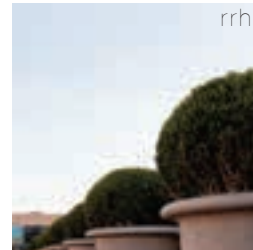

a

T8

T14

	a	b	h	w
A40	47cm	23cm	40cm	20kg
A50	56cm	25cm	49cm	30kg
A60	70cm	35cm	60cm	40kg
A70	75cm	40cm	70cm	55kg
A80	88cm	48cm	81cm	70kg
■ A110	120cm	62cm	110cm	180kg
■ A120	130cm	70cm	120cm	200kg
A40	18,5"	9"	15,7"	45lbs
A50	22"	9,8"	19,3"	65lbs
A60	27,5"	13,8"	23,6"	90lbs
A70	29,5"	15,7"	27,5"	120lbs
A80	34,6"	18,9"	31,9"	155lbs
■ A110	47,2"	24,4"	43,3"	396lbs
■ A120	51,2"	27,6"	47,2"	440lbs

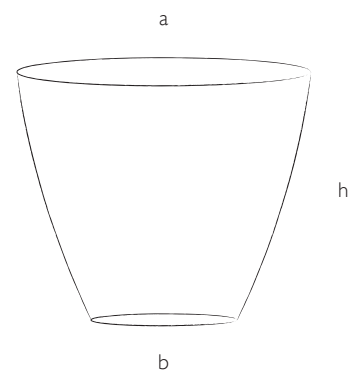

ab

T9

T14

	a	b	h	w
AB40	47cm	23cm	40cm	20kg
AB50	56cm	25cm	49cm	30kg
AB60	70cm	35cm	60cm	40kg
AB80	88cm	48cm	81cm	75kg
AB40	18,5"	9"	15,7"	45lbs
AB50	22"	9,8"	19,3"	65lbs
AB60	27,6"	13,8"	23,6"	88lbs
AB80	34,6"	18,9"	31,9"	165lbs

Following bark textures are possible:  
- white clay with grey texture  
- grey clay with black texture  
- black clay with red texture  
- red clay with black texture

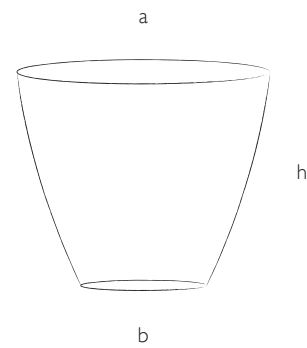

ah

T11

T13

	a	b	h	w
AH50	29cm	17cm	49cm	15kg
AH65	37cm	20cm	64cm	20kg
AH90*	42cm	26cm	90cm	35kg
AHB50	28cm	17cm	49cm	15kg
AHB65	37cm	20cm	64cm	20kg
AH50	11,4"	6,7"	19,3"	35lbs
AH65	14,6"	7,9"	25,2"	45lbs
AH90*	16,5"	10,2"	35,4"	77lbs
AHB50	11"	6,7"	19,3"	35lbs
AHB65	14,6"	7,9"	25,2"	45lbs

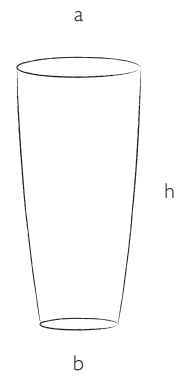

\* models suitable for a polyester innerliner.

AHB: Following bark textures are possible:

- white clay with grey texture
- grey clay with black texture
- black clay with red texture
- red clay with black texture



# ah130

T11

T13

	a	b	h	w
AH130	72cm	34cm	127cm	90kg
AH130	28,3"	13,4"	50"	200lbs

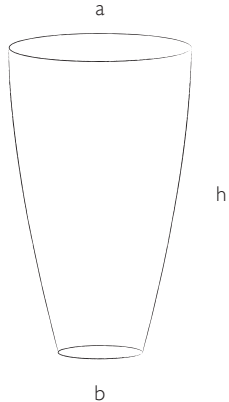

ah

T11

T12

T13

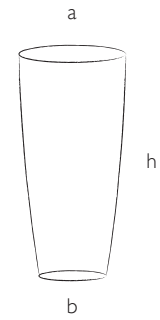

	a	b	h	w
AH140	60cm	45cm	140cm	90kg
AH180	88cm	53cm	180cm	150kg
AH220	100cm	65cm	226cm	250kg
AH140	23,6"	17,7"	55,1"	198,lbs
AH180	34,6"	20,8"	70,8"	330lbs
AH220	39,3"	25,5"	88,9"	551lbs





ahb180  
ahb220

T11  
T13



	a	b	h	w
AHB180	61cm	42cm	180cm	200kg
AHB220	70cm	50cm	220cm	300kg
AHB180	24"	16,5"	70,8"	440lbs
AHB220	27,5"	19,6"	86,6"	661lbs

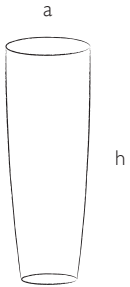

ahe

	a	b	h	w
AHE90	42cm	26cm	90cm	35kg
AHE90	16,5"	10,2"	35,4"	77lbs

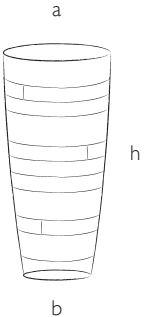

ahs180  
ahs220

T11  
T13

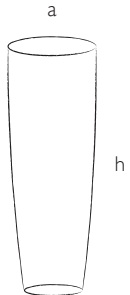

	a	b	h	w
AHS180	61cm	42cm	180cm	200kg
AHS220	70cm	50cm	220cm	300kg
AHS180	24"	16,5"	70,8"	440lbs
AHS220	27,5"	19,6"	86,6"	661lbs



ahsb180  
ahsb220

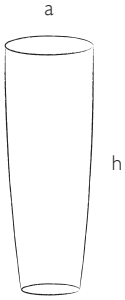

	a	b	h	w
AHSB180	61cm	42cm	180cm	200kg
AHSB220	70cm	50cm	220cm	300kg
AHSB180	24"	16,5"	70,8"	440lbs
AHSB220	27,5"	19,6"	86,6"	661lbs



ak

	a	h	w
AK60	70cm	60cm	40kg
AK70	75cm	70cm	55kg
AK80	88cm	81cm	70kg
AK60	27,6"	23,6"	88lbs
AK70	29,5"	27,5"	120lbs
AK80	34,6"	31,9"	155lbs

Different colour combinations are possible.  
Info upon request.

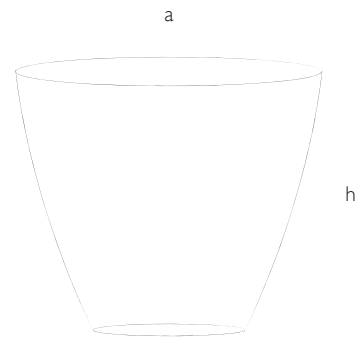

ap  
ahp

	a	b	h	w
AP40	47cm	23cm	40cm	20kg
AP80	89cm	49cm	81cm	80kg
AHP90	70cm	35cm	97cm	90kg
AHP130	73cm	35cm	127cm	120kg
AP40	18,5"	9"	15,7"	45lbs
AP80	35"	19,3"	31,9"	175lbs
AHP90	27,6"	13,8"	38,2"	200lbs
AHP130	28,7"	13,8"	50"	265lbs

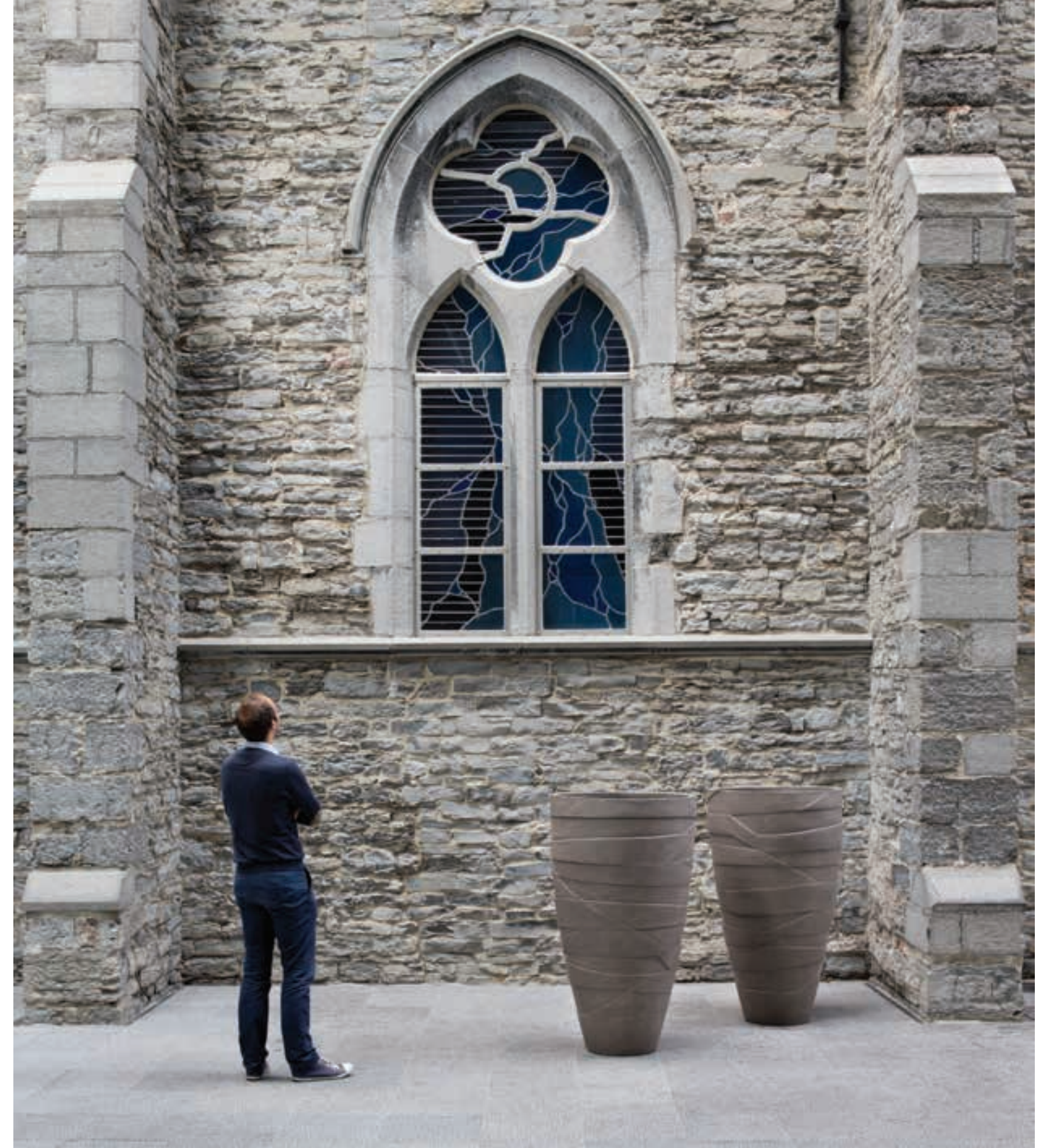
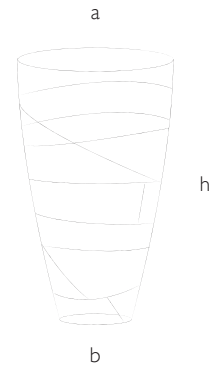

au  
aub

T<sub>8</sub>

T<sub>11</sub>

T<sub>14</sub>

	a	b	h	w
AU130 (right)	120cm	65cm	130cm	125g
AUB130 (left)	120cm	65cm	130cm	175kg
AU130 (right)	47,2"	25,5"	51,1"	275lbs
AUB130 (left)	47,2"	25,5"	51,1"	385lbs

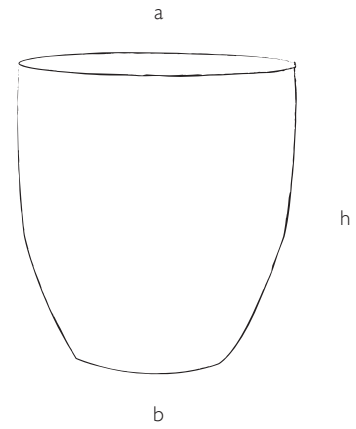

# aub180

T8

T11

T14

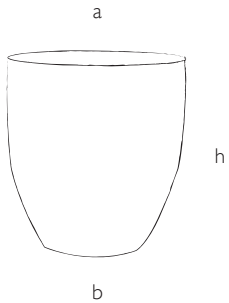

	a	b	h	w
AUB180	165cm	85cm	180cm	800kg
AUB180	64,9"	33,4"	70,8"	1763lbs





au  
aus

T11

T14

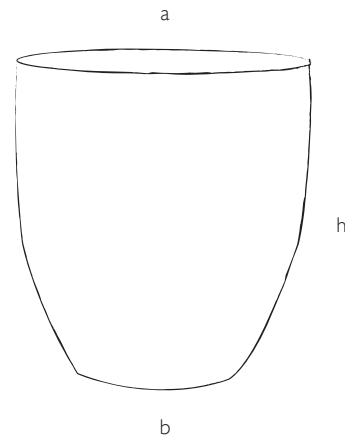

	a	b	h	w
AUX80	56cm	27cm	80cm	45kg
AUSX80	56cm	27cm	80cm	45kg
■ AU80	72cm	37cm	80cm	65kg
AUS80	72cm	37cm	80cm	65kg
AUX80	22"	10,6"	31,5"	99,2lbs
AUSX80	22"	10,6"	31,5"	99,2lbs
■ AU80	28,3"	14,6"	31,5"	143,3lbs
AUS80	28,3"	14,6"	31,5"	143,3lbs

AU and AUX have a standard texture

AUS and AUSX have the color texture like shown on the right

From left to right: AUSX80 black with red engobe, AUSX80 black with green engobe, AUS80 white with grey engobe.

From left to right: AUSX80 black with red engobe, AUSX80 black with green engobe, AUS80 white with grey engobe.



# aus100

T11

T14

	a	b	h	w
AUS100	90cm	45cm	100cm	250g
AUS100	35,4"	17,7"	39,3"	551lbs

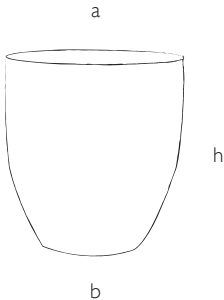

# aus180

T11

	a	b	h	w
AUS180	165cm	85cm	180cm	800kg
AUS180	64,9"	33,4"	70,8"	1763lbs

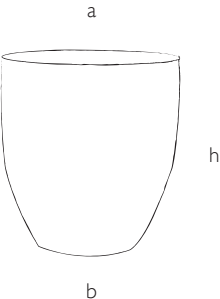

	a	c	h	w
B2080	20cm	20cm	80cm	20kg
B20100	20cm	20cm	100cm	25kg
B20120	20cm	20cm	120cm	30kg
■ B3060	28cm	28cm	55cm	25kg
■ B3080*	30cm	30cm	80cm	35kg
■ B30100*	30cm	30cm	100cm	40kg
■ B30120*	30cm	30cm	120cm	50kg
■ B4080*	38cm	38cm	80cm	45kg
■ B40100*	38cm	38cm	100cm	55kg
■ B40120*	40cm	40cm	120cm	65kg
■ B5060*	48cm	48cm	60cm	50kg
■ B5080*	48cm	48cm	80cm	60kg
■ B50100*	50cm	50cm	100cm	70kg
■ B50120*	50cm	50cm	120cm	80kg
■ B50140*	50cm	50cm	140cm	90kg
B2080	7,9"	7,9"	31,5"	45lbs
B20100	7,9"	7,9"	39,4"	55lbs
B20120	7,9"	7,9"	47,2"	65lbs
■ B3060	11"	11"	21,6"	55lbs
■ B3080*	11,8"	11,8"	31,5"	77lbs
■ B30100*	11,8"	11,8"	39,4"	88lbs
■ B30120*	11,8"	11,8"	47,2"	110lbs
■ B4080*	15"	15"	31,5"	100lbs
■ B40100*	15"	15"	39,4"	120lbs
■ B40120*	15,7"	15,7"	47,2"	145lbs
■ B5060*	18,9"	18,9"	23,6"	110lbs
■ B5080*	18,9"	18,9"	31,5"	130lbs
■ B50100*	19,7"	19,7"	39,4"	155lbs
■ B50120*	19,7"	19,7"	47,2"	175lbs
■ B50140*	19,7"	19,7"	55,1"	200lbs

\* models suitable for a polyester innerliner.

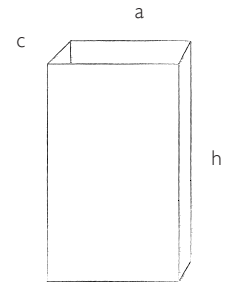

b

T10

	a	h	w
BE	45cm	90cm	50kg
BV	45cm	90cm	50kg
BVT	45cm	90cm	50kg
BVR	45cm	90cm	50kg
BE	17,7"	35,4"	19,6lbs
BV	17,7"	35,4"	19,6lbs
BVT	17,7"	35,4"	19,6lbs
BVR	17,7"	35,4"	19,6lbs

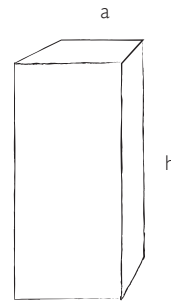

BE



BV



BVT



BVR



# b cube

T6

	a	h	w
B3030	30cm	30cm	15kg
B4040	40cm	40cm	20kg
B5050*	50cm	50cm	50kg
B6060	60cm	60cm	70kg
B7070	70cm	70cm	85kg
<i>B3030</i>	<i>11,8"</i>	<i>11,8"</i>	<i>35lbs</i>
<i>B4040</i>	<i>15,7"</i>	<i>15,7"</i>	<i>45lbs</i>
<i>B5050*</i>	<i>19,7"</i>	<i>19,7"</i>	<i>110lbs</i>
<i>B6060</i>	<i>23,6"</i>	<i>23,6"</i>	<i>155lbs</i>
<i>B7070</i>	<i>27,6"</i>	<i>27,6"</i>	<i>190lbs</i>

\* models suitable for a polyester innerliner.

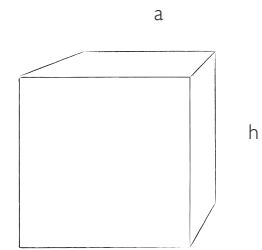

bc

T6

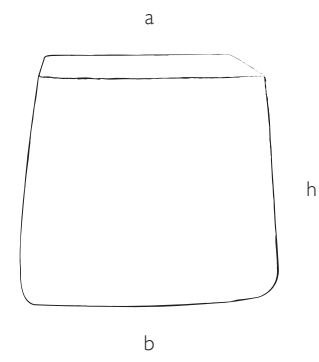

	a	b	h	w
BC50	55cm	60cm	53cm	50kg
BC50	21,6"	23,6"	20,8"	110lbs



bch

T6

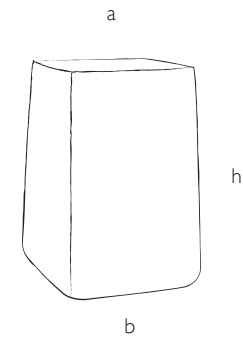

	a	b	h	w
BCH90	55cm	60cm	90cm	75kg
BCH90	21,6"	23,6"	35,4"	165lbs





# bch150

T6

	a	b	h	w
BCH150	45cm	50cm	150cm	100kg
BCH150	17,7"	19,6"	59"	220lbs

Possibility to have personalized engraving.

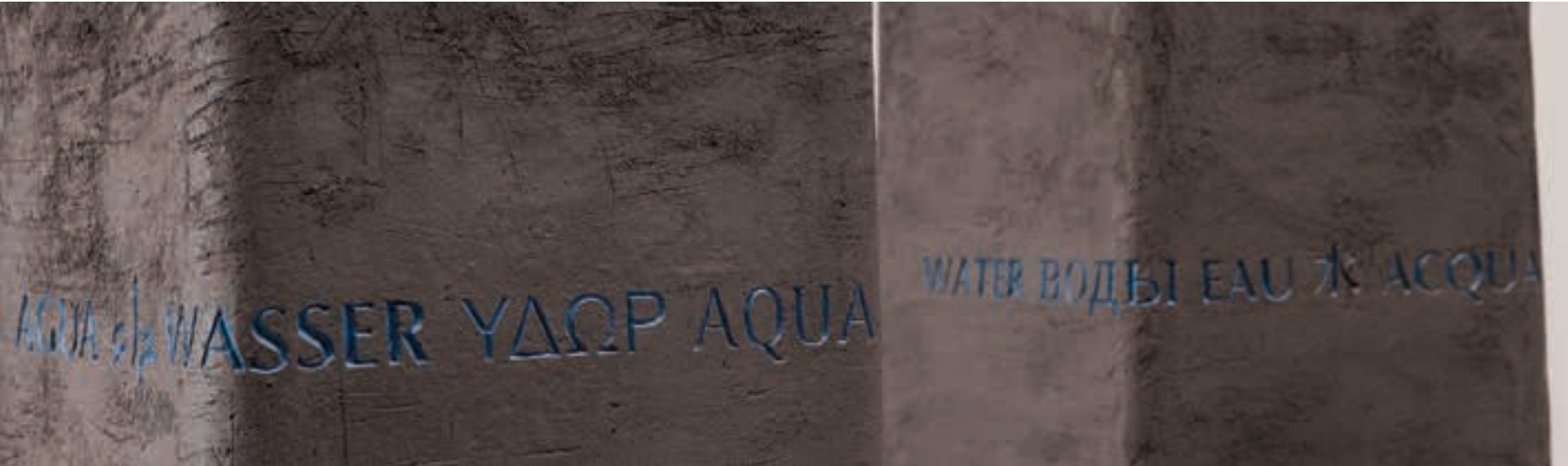
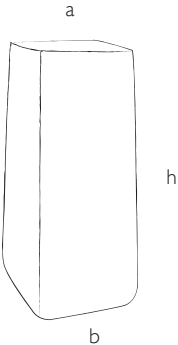

bg

T10

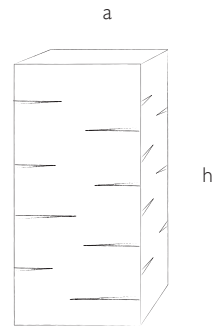

	a	h	w
BG5050	50cm	50cm	50kg
BG40120*	40cm	120cm	75kg
BG5050	19,7"	19,7"	110lbs
BG40120*	15,7"	47,2"	165lbs

\* models suitable for a polyester innerliner.



bl

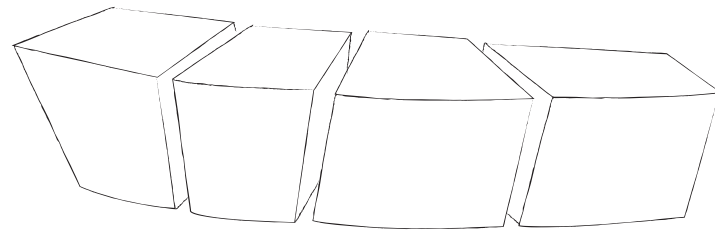

With a total length of over 1,8m, the BL model is available as a total installation, as well as in individual parts.

More detailed info on request.





bm

T5

	a	h	w
BM5050	50cm	50cm	45kg
BM40120*	40cm	120cm	60kg
BM50100*	50cm	100cm	65kg
<i>BM5050</i>	<i>19,7"</i>	<i>19,7"</i>	<i>100lbs</i>
<i>BM40120*</i>	<i>15,7"</i>	<i>47,2"</i>	<i>130lbs</i>
<i>BM50100*</i>	<i>19,7"</i>	<i>39,4"</i>	<i>145lbs</i>

\* models suitable for a polyester innerliner.

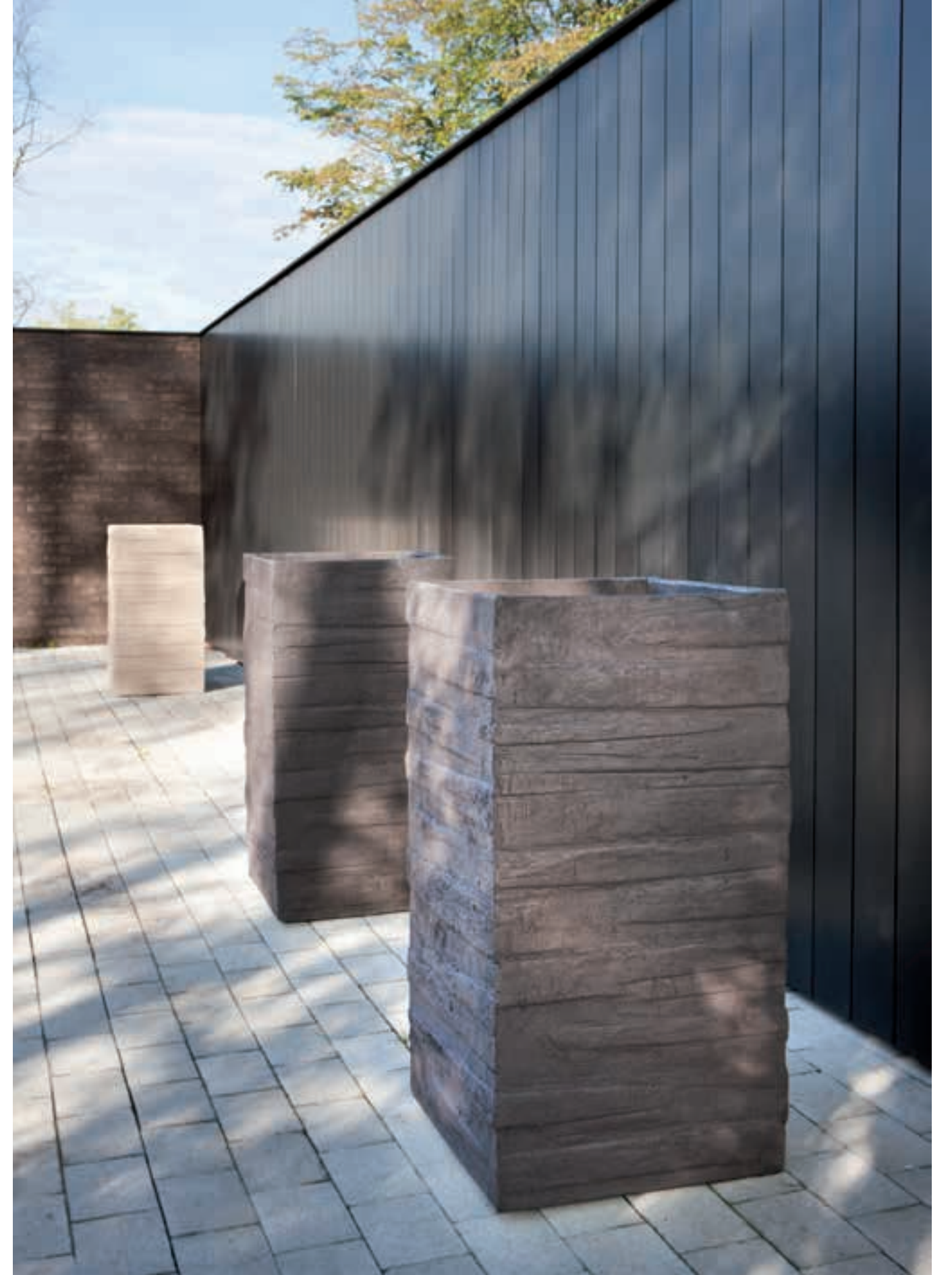
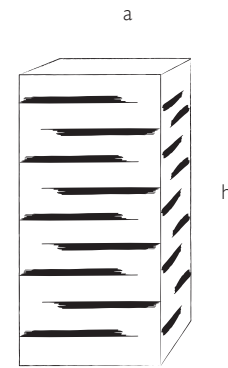



bp

	a	h	w
BP60	60cm	60cm	60kg
BP60	23,6"	23,6"	135lbs

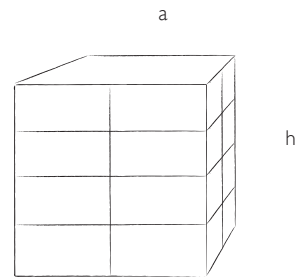

br

T<sub>2</sub>

T<sub>5</sub>

T<sub>10</sub>

	a	c	h	w
BR55	45cm	25cm	55cm	30kg
BR80*	50cm	30cm	80cm	50kg
BR100*	50cm	30cm	100cm	60kg
BR120*	50cm	30cm	120cm	70kg
<i>BR55</i>	<i>17,2"</i>	<i>9,8"</i>	<i>21,6"</i>	<i>65lbs</i>
<i>BR80*</i>	<i>19,7"</i>	<i>11,8"</i>	<i>31,5"</i>	<i>110lbs</i>
<i>BR100*</i>	<i>19,7"</i>	<i>11,8"</i>	<i>39,4"</i>	<i>135lbs</i>
<i>BR120*</i>	<i>19,7"</i>	<i>11,8"</i>	<i>47,2"</i>	<i>155lbs</i>

\* models suitable for polyester innerliner

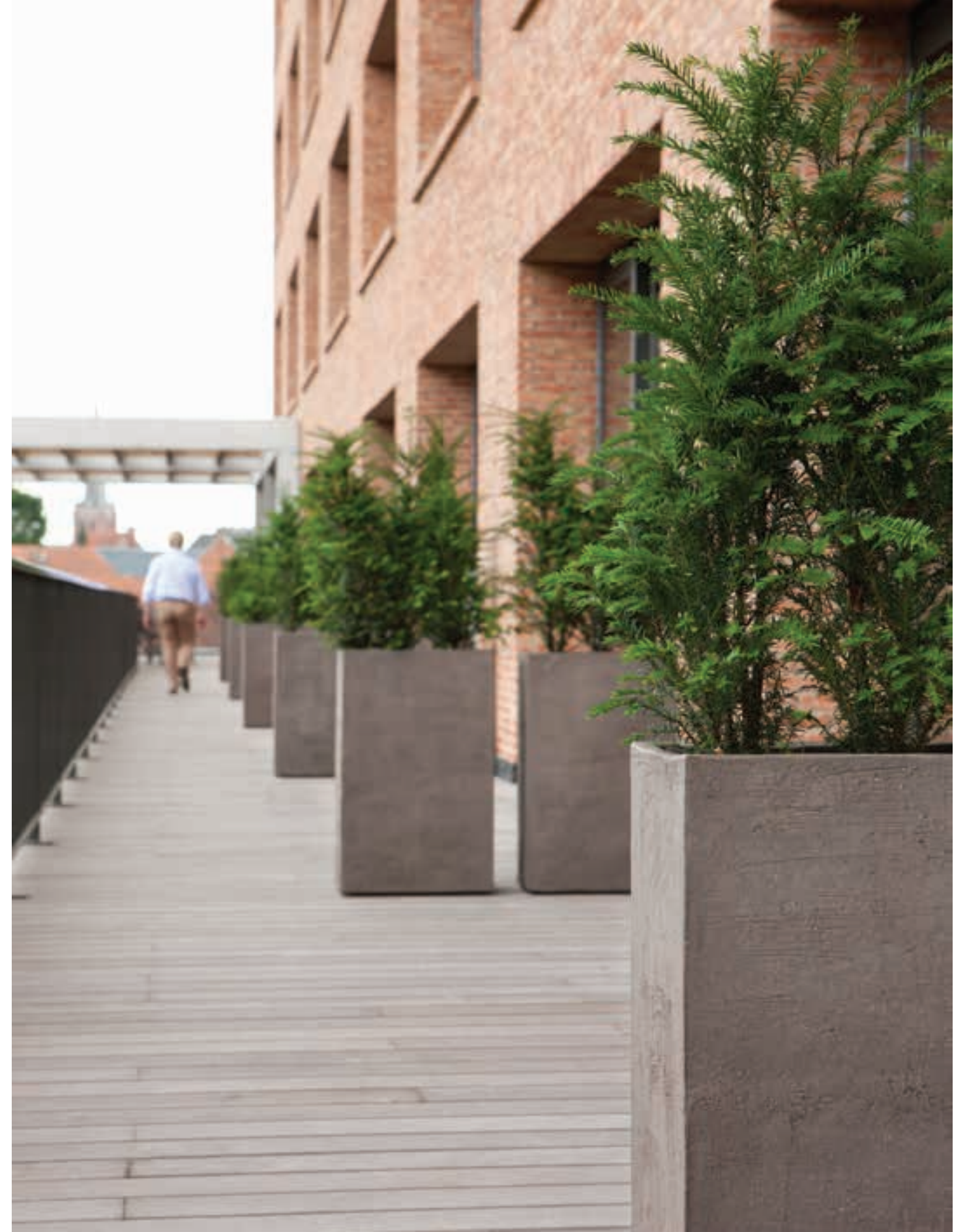
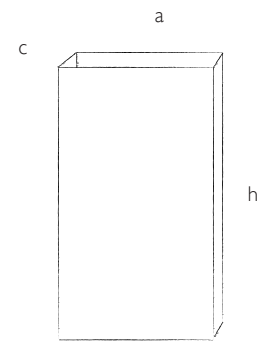



brf

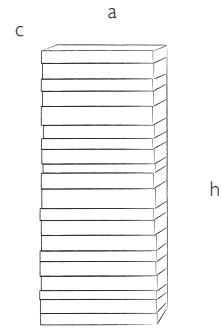

	a	c	h	w
BRF100	50cm	35cm	100cm	100kg
BRF120	50cm	35cm	120cm	115kg
<i>BRF100</i>	<i>19,7"</i>	<i>13,8"</i>	<i>39,4"</i>	<i>220lbs</i>
<i>BRF120</i>	<i>19,7"</i>	<i>13,8"</i>	<i>47,2"</i>	<i>255lbs</i>

All BRF models are suitable for a polyester innerliner.



brl

T<sub>2</sub>

T<sub>5</sub>

T<sub>10</sub>

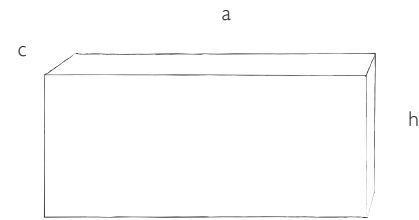

	a	c	h	w
BRL6040	60cm	30cm	40cm	40kg
BRL6060	60cm	30cm	60cm	45kg
BRL6080	60cm	30cm	80cm	55kg
BRL8040	80cm	30cm	40cm	50kg
BRL8060	80cm	30cm	60cm	75kg
BRL8080	80cm	30cm	80cm	85kg
BRL10040	100cm	30cm	40cm	65kg
BRL10060	100cm	30cm	60cm	85kg
BRL10080	100cm	30cm	80cm	105kg
<i>BRL6040</i>	<i>23,6"</i>	<i>11,8"</i>	<i>15,7"</i>	<i>90lbs</i>
<i>BRL6060</i>	<i>23,6"</i>	<i>11,8"</i>	<i>23,6"</i>	<i>100lbs</i>
<i>BRL6080</i>	<i>23,6"</i>	<i>11,8"</i>	<i>31,5"</i>	<i>120lbs</i>
<i>BRL8040</i>	<i>31,5"</i>	<i>11,8"</i>	<i>15,7"</i>	<i>110lbs</i>
<i>BRL8060</i>	<i>31,5"</i>	<i>11,8"</i>	<i>23,6"</i>	<i>165lbs</i>
<i>BRL8080</i>	<i>31,5"</i>	<i>11,8"</i>	<i>31,5"</i>	<i>185lbs</i>
<i>BRL10040</i>	<i>39,4"</i>	<i>11,8"</i>	<i>15,7"</i>	<i>145lbs</i>
<i>BRL10060</i>	<i>39,4"</i>	<i>11,8"</i>	<i>23,6"</i>	<i>190lbs</i>
<i>BRL10080</i>	<i>39,4"</i>	<i>11,8"</i>	<i>31,5"</i>	<i>230lbs</i>

Customized sizes are possible.  
Info upon request.



bs

	a	b	h	w
BS40	40cm	40cm	50cm	30kg
BS50	50cm	50cm	60cm	45kg
BS75	50cm	50cm	75cm	60kg
BS40	15,7"	15,7"	19,6"	65lbs
BS50	19,6"	19,6"	23,6"	100lbs
BS75	19,6"	19,6"	29,5"	132lbs

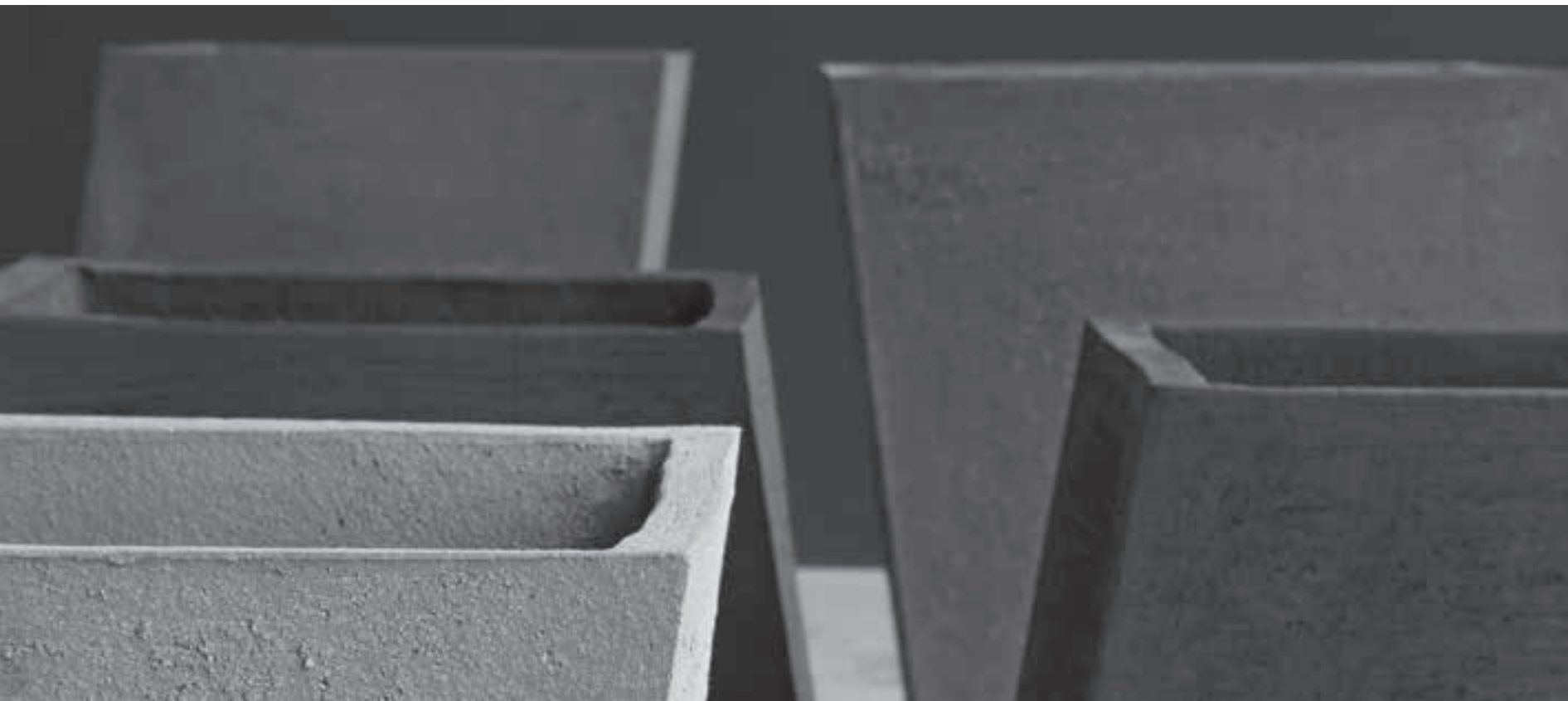
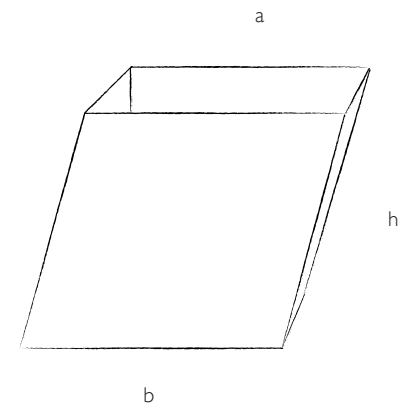

bt

	a	h	w
BT4080	46cm	80cm	50kg
BT40100	46cm	100cm	60kg
BT40120	46cm	120cm	80kg
BT5080	56cm	80cm	70kg
BT50100	56cm	100cm	95kg
BT50120	56cm	120cm	110kg
<i>BT4080</i>	<i>18,1"</i>	<i>31,5"</i>	<i>110lbs</i>
<i>BT40100</i>	<i>18,1"</i>	<i>39,4"</i>	<i>135lbs</i>
<i>BT40120</i>	<i>18,1"</i>	<i>47,2"</i>	<i>175lbs</i>
<i>BT5080</i>	<i>22"</i>	<i>31,5"</i>	<i>155lbs</i>
<i>BT50100</i>	<i>22"</i>	<i>39,4"</i>	<i>210lbs</i>
<i>BT50120</i>	<i>22"</i>	<i>47,2"</i>	<i>245lbs</i>

All BT-models are suitable for a polyester innerliner.

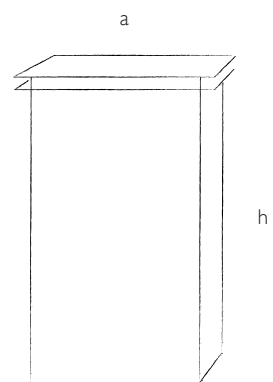

bte

	a	h	w
BTE4080	46cm	80cm	50kg
BTE40100	46cm	100cm	60kg
BTE40120	46cm	120cm	80kg
BTE5080	56cm	80cm	70kg
BTE50100	56cm	100cm	95kg
BTE50120	56cm	120cm	110kg
<i>BTE4080</i>	<i>18,1"</i>	<i>31,5"</i>	<i>110lbs</i>
<i>BTE40100</i>	<i>18,1"</i>	<i>39,4"</i>	<i>135lbs</i>
<i>BTE40120</i>	<i>18,1"</i>	<i>47,2"</i>	<i>175lbs</i>
<i>BTE5080</i>	<i>22"</i>	<i>31,5"</i>	<i>155lbs</i>
<i>BTE50100</i>	<i>22"</i>	<i>39,4"</i>	<i>210lbs</i>
<i>BTE50120</i>	<i>22"</i>	<i>47,2"</i>	<i>245lbs</i>

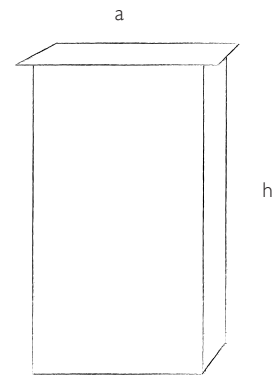

All BTE models are suitable for a polyester innerliner.





bTV

	a	h	w
BTV3080	30cm	85cm	40kg
BTV30100	30cm	105cm	45kg
BTV4080	38cm	85cm	50kg
BTV40100	38cm	105cm	60kg
BTV40120	40cm	125cm	80kg
BTV5080	48cm	85cm	75kg
BTV50100	50cm	105cm	100kg
BTV50120	50cm	125cm	120kg
BTV50140	50cm	145cm	130kg
<i>BTV3080</i>	<i>11,8"</i>	<i>33,4"</i>	<i>88lbs</i>
<i>BTV30100</i>	<i>11,8"</i>	<i>41,3"</i>	<i>100lbs</i>
<i>BTV4080</i>	<i>15"</i>	<i>33,4"</i>	<i>110lbs</i>
<i>BTV40100</i>	<i>15"</i>	<i>41,3"</i>	<i>135lbs</i>
<i>BTV40120</i>	<i>15,7"</i>	<i>49,2"</i>	<i>175lbs</i>
<i>BTV5080</i>	<i>18,9"</i>	<i>33,4"</i>	<i>165lbs</i>
<i>BTV50100</i>	<i>19,7"</i>	<i>41,3"</i>	<i>220lbs</i>
<i>BTV50120</i>	<i>19,7"</i>	<i>49,2"</i>	<i>265lbs</i>
<i>BTV50140</i>	<i>19,7"</i>	<i>57,1"</i>	<i>285lbs</i>

BTV includes pedestal and plate.

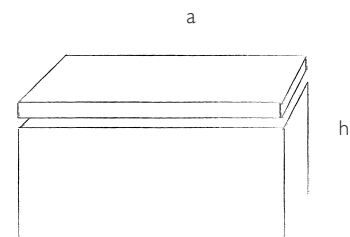

bz

	a	h	w
BZ4080	38cm	80cm	45kg
BZ40100	38cm	100cm	55kg
BZ40120	40cm	120cm	60kg
BZ5060	50cm	60cm	50kg
BZ5080	48cm	80cm	60kg
BZ50100	50cm	100cm	70kg
BZ50120	50cm	120cm	80kg
BZ50140	50cm	140cm	90kg
<i>BZ4080</i>	<i>15"</i>	<i>31,5"</i>	<i>100lbs</i>
<i>BZ40100</i>	<i>15"</i>	<i>39,4"</i>	<i>120lbs</i>
<i>BZ40120</i>	<i>15,7"</i>	<i>47,2"</i>	<i>130lbs</i>
<i>BZ5060</i>	<i>19,7"</i>	<i>23,6"</i>	<i>110lbs</i>
<i>BZ5080</i>	<i>18,9"</i>	<i>31,5"</i>	<i>130lbs</i>
<i>BZ50100</i>	<i>19,7"</i>	<i>39,4"</i>	<i>155lbs</i>
<i>BZ50120</i>	<i>19,7"</i>	<i>47,2"</i>	<i>175lbs</i>
<i>BZ50140</i>	<i>19,7"</i>	<i>55,1"</i>	<i>200lbs</i>

All BZ models are suitable for a polyester innerliner.

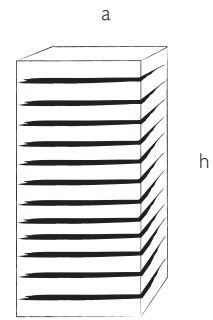



cb

T1

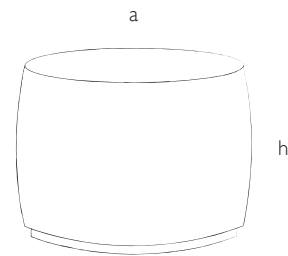

	a	h	w
CB70	72cm	56cm	75kg
CB70	28,4"	22"	165lbs



cbh

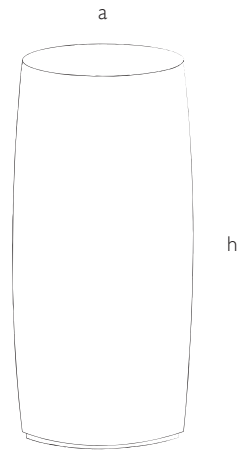

	a	h	w
CBH80	32cm	80cm	40kg
CBH100	38cm	100cm	65kg
CBH80	13,8"	31,5"	88lbs
CBH100	14,9"	39,4"	143lbs



cbh180

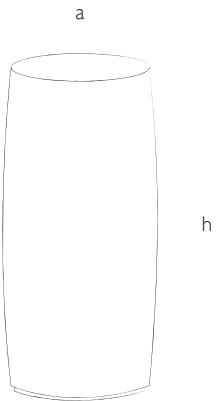

	a	h	w
CBH180	55cm	180cm	150kg
CBH180	21,6"	70,8"	330lbs



cbt

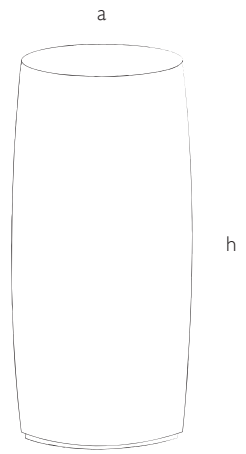

	a	h	w
CBT80	32cm	80cm	40kg
CBT100	38cm	100cm	65kg
CBT80	13,8"	31,5"	88lbs
CBT100	14,9"	39,4"	143lbs

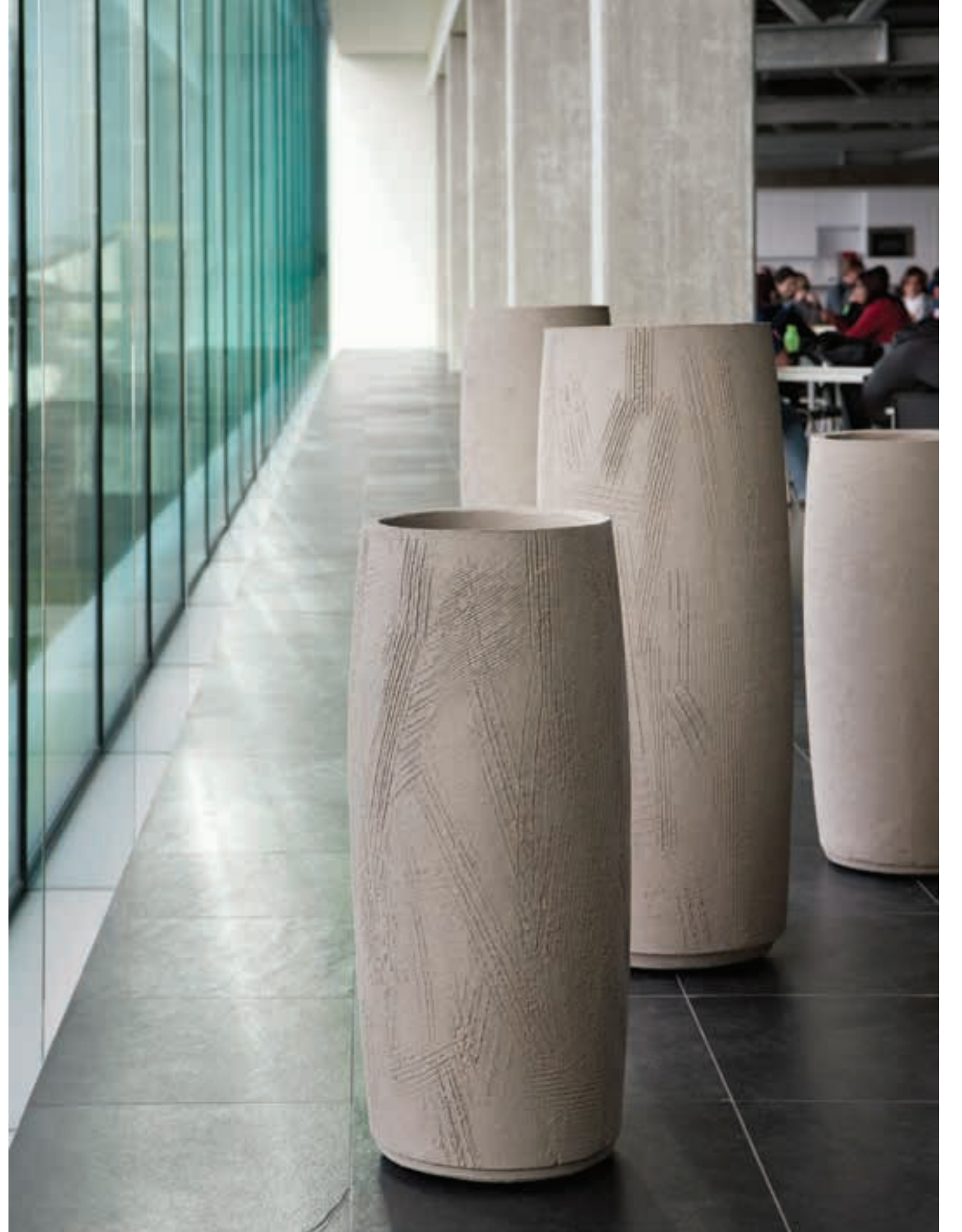

cg

	a	b	h	w
CG130	39cm	30cm	128cm	110kg
CG130	15,3"	11,8"	50,4"	245lbs

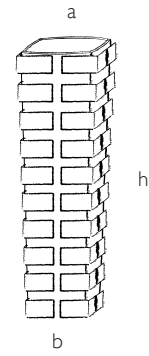

ck

T1

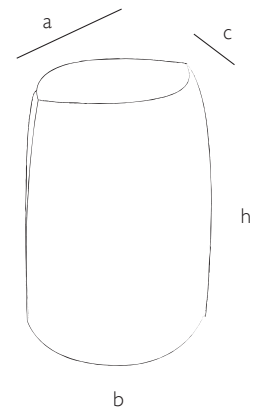

	a	c	b	h	w
CK60	41cm	30cm	45cm	60cm	30kg
CKB60	41cm	30cm	45cm	60cm	30kg
CK80	56cm	42cm	61cm	82cm	60kg
CKB80	56cm	42cm	61cm	82cm	60kg
<i>CK60</i>	<i>16,1"</i>	<i>11,8"</i>	<i>17,7"</i>	<i>23,6"</i>	<i>66,1lbs</i>
<i>CKB60</i>	<i>16,1"</i>	<i>11,8"</i>	<i>17,7"</i>	<i>23,6"</i>	<i>66,1lbs</i>
<i>CK80</i>	<i>22"</i>	<i>16,5"</i>	<i>24"</i>	<i>32,3"</i>	<i>132,2lbs</i>
<i>CKB80</i>	<i>22"</i>	<i>16,5"</i>	<i>24"</i>	<i>32,3"</i>	<i>132,2lbs</i>

CK has a standard texture  
CKB has a rougher texture





cl

	a	h	w
CL40	35cm	40cm	25kg
CL50	50cm	50cm	30kg
CLL50	50cm	21cm	25kg
CL60*	60cm	65cm	50kg
CL80	80cm	45cm	70kg
<i>CL40</i>	<i>13,8"</i>	<i>15,7"</i>	<i>55lbs</i>
<i>CL50</i>	<i>19,7"</i>	<i>19,7"</i>	<i>65lbs</i>
<i>CLL50</i>	<i>19,7"</i>	<i>8,2"</i>	<i>55lbs</i>
<i>CL60*</i>	<i>23,6"</i>	<i>25,6"</i>	<i>110lbs</i>
<i>CL80</i>	<i>31,5"</i>	<i>17,7"</i>	<i>155lbs</i>

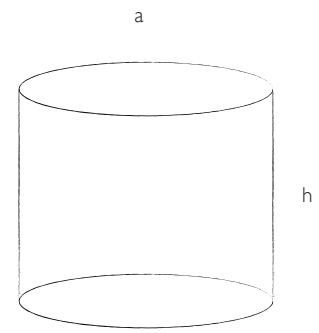

\* models suitable for a polyester innerliner.





# clh100

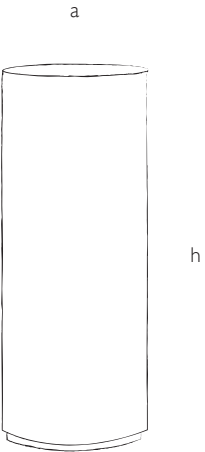

	a	h	w
CLH100	38cm	100cm	50kg
CLH100	14,9"	39,3"	110lbs

Different combinations are possible.



clk

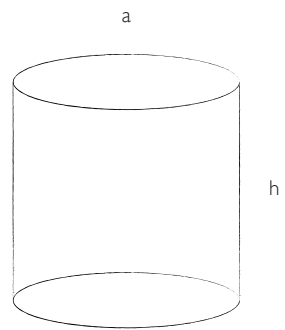

	a	h	w
CLK40	40cm	40cm	25kg
CLK50	50cm	50cm	35kg
CLK60	60cm	60cm	50kg
CLK40	15,7"	15,7"	55lbs
CLK50	19,6"	19,6"	77lbs
CLK60	23,6"	23,6"	110lbs

Different colour combinations are possible.  
Info upon request.



CV

T<sub>1</sub>

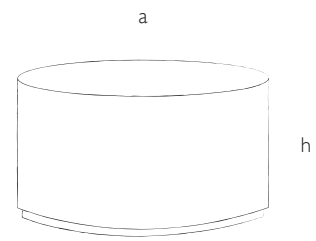

	a	h	w
CV70	70cm	42cm	70kg
CV70	27,6"	16,5"	155lbs



CVi

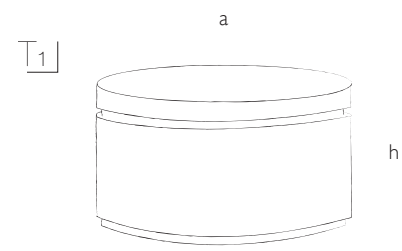

	a	h	w
CV170	70cm	42cm	70kg
CV170	27,6"	16,5"	155lbs



dm  
dmb

T<sub>8</sub>L

	a	b	c	h	w
DM80 (left)	69cm	47cm	80cm	72cm	70kg
■ DMB80 (right)	69cm	47cm	80cm	72cm	90kg
DM80 (left)	27,1"	18,5"	31,5"	28,3"	154lbs
■ DM80 (right)	27,1"	18,5"	31,5"	28,3"	198lbs

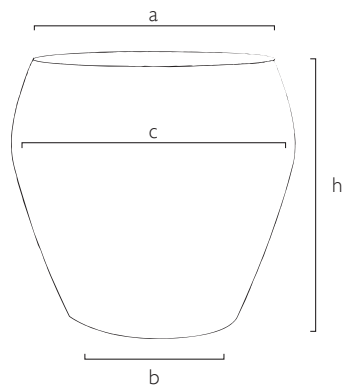

dvh

	a	h	w
DVH50	50cm	31cm	35kg
DVH50	19,7"	12,2"	77lbs

Different combinations in bowl and pedestal are possible.  
Info upon request. DVH is not suitable for outside use during frost.

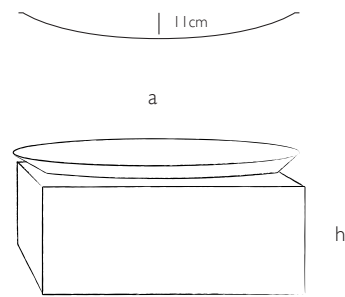

dvs

	a	h	w
DVS60	60cm	10cm	25kg
DVS60	23,6"	3,9"	55lbs

DVS is not suitable for outside use during frost.

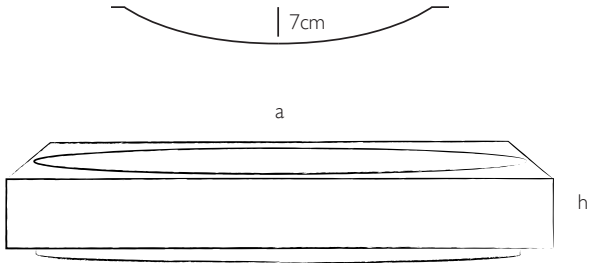

em

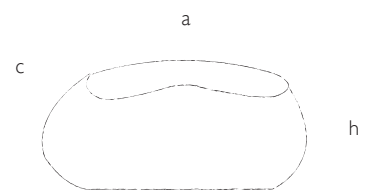

	a	c	h	w
EM60	60cm	43cm	39cm	30kg
EM70	70cm	45cm	39cm	40kg
EM90	90cm	69cm	49cm	75kg
EM100	100cm	67cm	56cm	90kg
<i>EM60</i>	<i>23,6"</i>	<i>16,9"</i>	<i>15,3"</i>	<i>66lbs</i>
<i>EM70</i>	<i>27,5"</i>	<i>17,7"</i>	<i>15,3"</i>	<i>88lbs</i>
<i>EM90</i>	<i>35,4"</i>	<i>27,1"</i>	<i>19,2"</i>	<i>165lbs</i>
<i>EM100</i>	<i>29,3"</i>	<i>26,3"</i>	<i>22"</i>	<i>198lbs</i>





dv

	a	c	h	w
DV20	45cm	45cm	20cm	25kg
DV90	45cm	45cm	90cm	75kg
<i>DV20</i>	<i>17,7"</i>	<i>17,7"</i>	<i>20"</i>	<i>55lbs</i>
<i>DV90</i>	<i>17,7"</i>	<i>17,7"</i>	<i>35,4"</i>	<i>165lbs</i>

DV is not suitable for outside use during frost

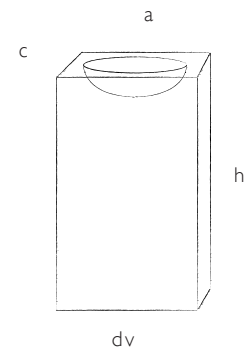

hk

	a	h	w
HK40	66cm	29cm	20kg
HK60	90cm	57cm	45kg
HKL40	69cm	19cm	15kg
HK90	107cm	72cm	95kg
HK130	140cm	100cm	150kg
<i>HK40</i>	<i>26"</i>	<i>11,4"</i>	<i>45lbs</i>
<i>HK60</i>	<i>35,4"</i>	<i>22,4"</i>	<i>100lbs</i>
<i>HKL40</i>	<i>27,1"</i>	<i>7,5"</i>	<i>33lbs</i>
<i>HK90</i>	<i>47,2"</i>	<i>35,4"</i>	<i>210lbs</i>
<i>HK130</i>	<i>55,1"</i>	<i>39,4"</i>	<i>330lbs</i>

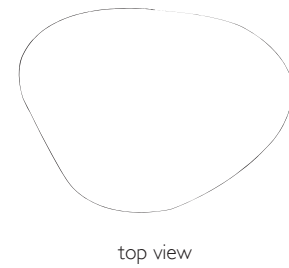
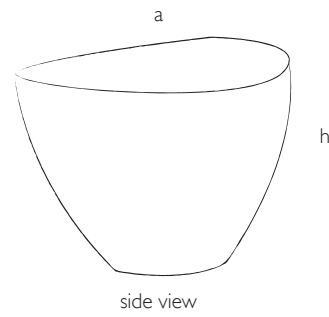

hv

T14

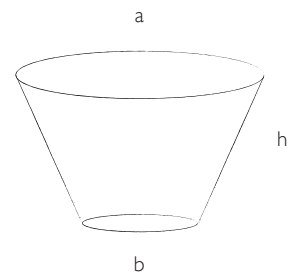

	a	b	h	w
HV50	48cm	20cm	28cm	20kg
■ HV60	59cm	25cm	33cm	25kg
HV80	78cm	37cm	53cm	45kg
HV130	130cm	80cm	65cm	150kg
HV140	140cm	90cm	100cm	200kg
HVR140	140cm	90cm	100cm	200kg
<i>HV50</i>	<i>18,9"</i>	<i>7,9"</i>	<i>11"</i>	<i>45lbs</i>
■ <i>HV60</i>	<i>23,2"</i>	<i>9,8"</i>	<i>13"</i>	<i>55lbs</i>
<i>HV80</i>	<i>30,7"</i>	<i>14,6"</i>	<i>20,9"</i>	<i>100lbs</i>
<i>HV130</i>	<i>51,2"</i>	<i>31,5"</i>	<i>25,6"</i>	<i>330lbs</i>
<i>HV140</i>	<i>55,1"</i>	<i>35,4"</i>	<i>39,4"</i>	<i>440lbs</i>
<i>HVR140</i>	<i>55,1"</i>	<i>35,4"</i>	<i>39,4"</i>	<i>440lbs</i>



hvf

	a	b	h	w
HVF80	78cm	37cm	53cm	65kg
HVF80	30,7"	14,6"	20,9"	145lbs

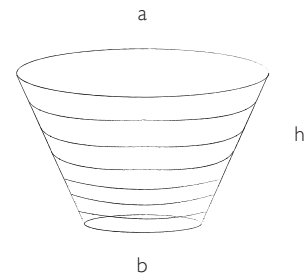

kb

kb

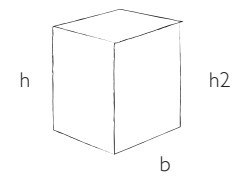

kbs

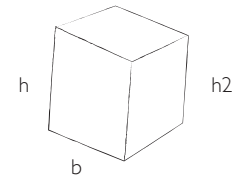

	b	h	h2	w
KB40	40cm	51cm	51cm	50kg
KB45	45cm	51cm	51cm	60kg
KBS40	40cm	51cm	44cm	50kg
KBS45	45cm	51cm	45cm	60kg
KB40	15,7"	20,1"	20,1"	110lbs
KB45	17,7"	20,1"	20,1"	132lbs
KBS40	15,7"	20,1"	17,3"	110lbs
KBS45	17,7"	20,1"	17,7"	132lbs

KB40 and KB45 are straight pedestals  
KBS40 and KBS45 are slightly slanted



K

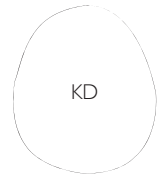
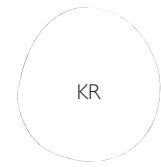
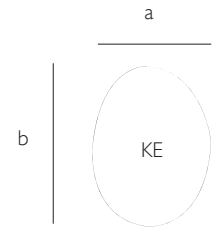

	a	b	h	w
KE70	52cm	70cm	38cm	45kg
KE100	75cm	100cm	56cm	100kg
KR70	65cm	70cm	40cm	45kg
KR85	76cm	82cm	45cm	75kg
KR100	88cm	95cm	50cm	100kg
KR150	130cm	143cm	80cm	200kg
KD70	60cm	72cm	44cm	45kg
KD85	76cm	82cm	45cm	75kg
KD100	86cm	102cm	58cm	100kg

	a	b	h	w
KE70	20,4"	27,5"	14,9"	99lbs
KE100	29,5"	39,3"	22"	220lbs
KR70	25,5"	27,5"	15,7"	99lbs
KR85	29,9"	32,3"	17,7"	165lbs
KR100	34,6"	37,4"	19,6"	220lbs
KR150	51,1"	56,2"	31,4"	440lbs
KD70	23,6"	28,3"	17,3"	99lbs
KD85	29,9"	32,3"	17,7"	165lbs
KD100	33,8"	40,1"	22,8"	220lbs



Chambres d'Amis  
Collectie / Collection

# kr150

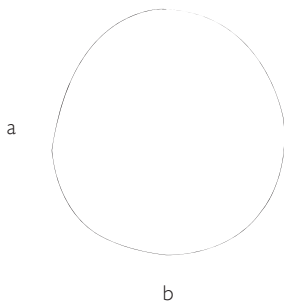

	a	b	h	w
KR150	143cm	130cm	80cm	200kg
KR150	56,2"	51,1"	31,4"	440lbs







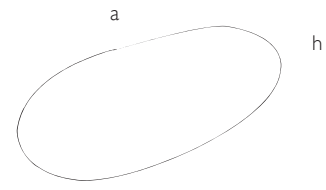

	a	h	w
KL120	116cm	30cm	60kg
KL120	45,6"	11,8"	132lbs





kka

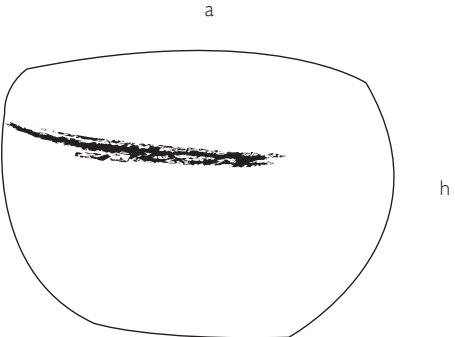

	a	h	w
KKA80	80cm	47cm	80kg
KKA100	108cm	58cm	120kg
KKA80	31,5"	18,5"	176lbs
KKA100	42,5"	22,8"	264lbs



kkb

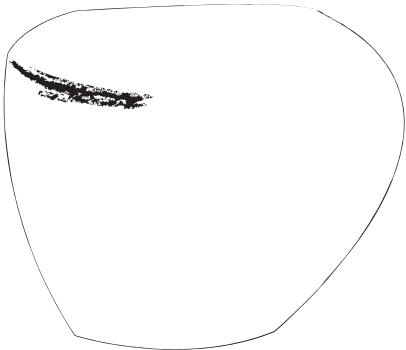

	a	h	w
KKB70	75cm	63cm	80kg
KKB70	29,5"	24,8"	176lbs



kkc

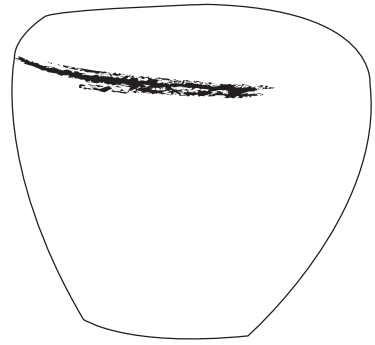

	a	h	w
KKC70	67cm	60cm	80kg
KKC70	26,4"	23,6"	176lbs





# L1a

	a	h	w
BT5080	60cm	80cm	75kg
BT50100	60cm	100cm	100kg
BT50120	60cm	120cm	115kg
<i>BT5080</i>	<i>23,6"</i>	<i>31,5"</i>	<i>165lbs</i>
<i>BT50100</i>	<i>23,6"</i>	<i>39,4"</i>	<i>220lbs</i>
<i>BT50120</i>	<i>23,6"</i>	<i>47,2"</i>	<i>255lbs</i>

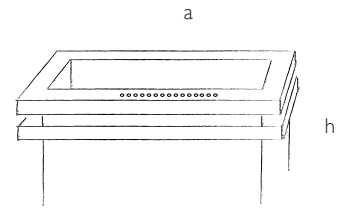

L1a is only available on a BT-vase with double rim. L1a is used to illuminate the plants inside the vase from beneath. Possibility to use led frame on both sides.

All L1a models are suitable for a polyester innerliner.



# L2

	a	h	w
BTE5080	60cm	80cm	70kg
BTE50100	60cm	100cm	95kg
BTE50120	60cm	120cm	110kg
<i>BTE5080</i>	<i>23,6"</i>	<i>31,5"</i>	<i>155lbs</i>
<i>BTE50100</i>	<i>23,6"</i>	<i>39,4"</i>	<i>210lbs</i>
<i>BTE50120</i>	<i>23,6"</i>	<i>47,2"</i>	<i>245lbs</i>

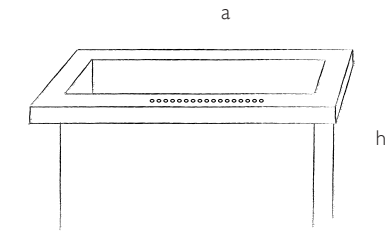

L2 is only available on a BTE-vase with single rim. L2 is used to illuminate the plants inside the vase from beneath. Possibility to use led frame on both sides.

All L2 models are suitable for a polyester innerliner.



# L3

	a	h	w
BTV4080	38cm	85cm	50kg
BTV40100	38cm	105cm	60kg
BTV40120	40cm	125cm	70kg
BTV5080	48cm	85cm	75kg
BTV50100	50cm	105cm	100kg
BTV50120	50cm	125cm	120kg
BTV50140	50cm	145cm	130kg
<i>BTV4080</i>	<i>15"</i>	<i>33,4"</i>	<i>110lbs</i>
<i>BTV40100</i>	<i>15"</i>	<i>41,3"</i>	<i>135lbs</i>
<i>BTV40120</i>	<i>15,7"</i>	<i>49,2"</i>	<i>155lbs</i>
<i>BTV5080</i>	<i>18,9"</i>	<i>33,4"</i>	<i>165lbs</i>
<i>BTV50100</i>	<i>19,7"</i>	<i>41,3"</i>	<i>220lbs</i>
<i>BTV50120</i>	<i>19,7"</i>	<i>49,2"</i>	<i>265lbs</i>
<i>BTV50140</i>	<i>19,7"</i>	<i>57,1"</i>	<i>285lbs</i>

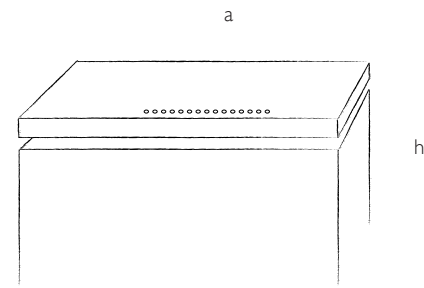

L3 is only available on the BTV-vase. L3 is used on a pedestal in order to illuminate an exposed object, objet d'art or other. Possibility to use led frame on both sides.





L4

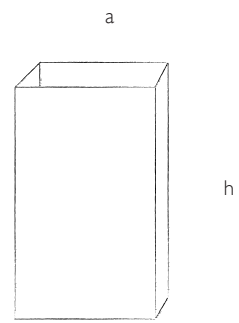

	a	h	w
L4 4580	45cm	78cm	60kg
L4 4580	17,7"	30,7"	132lbs



option 1



option 2



lc

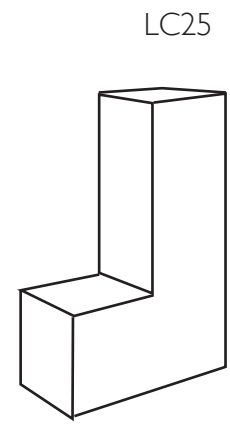
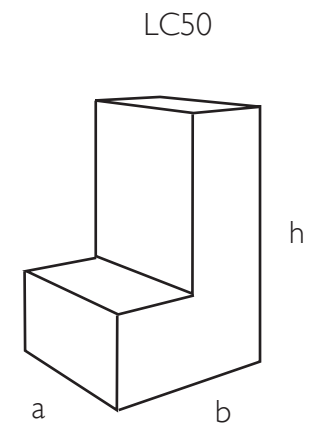

	a	b	h	w
LC50	50cm	50cm	75cm	40kg
LC50	17,9"	17,9"	29,5"	88,2lbs

	a	b	h	w
LC25	25cm	50cm	75cm	30kg
LC25	9,8"	17,9"	29,5"	66,1lbs



lw

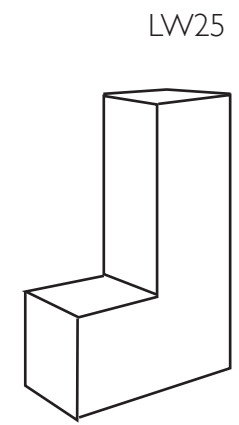
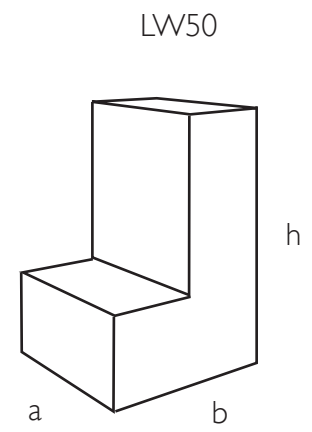

	a	b	h	w
LW50	50cm	50cm	75cm	25kg
LW50	17,9"	17,9"	29,5"	55lbs

	a	b	h	w
LW25	25cm	50cm	75cm	20kg
LW25	9,8"	17,9"	29,5"	40lbs

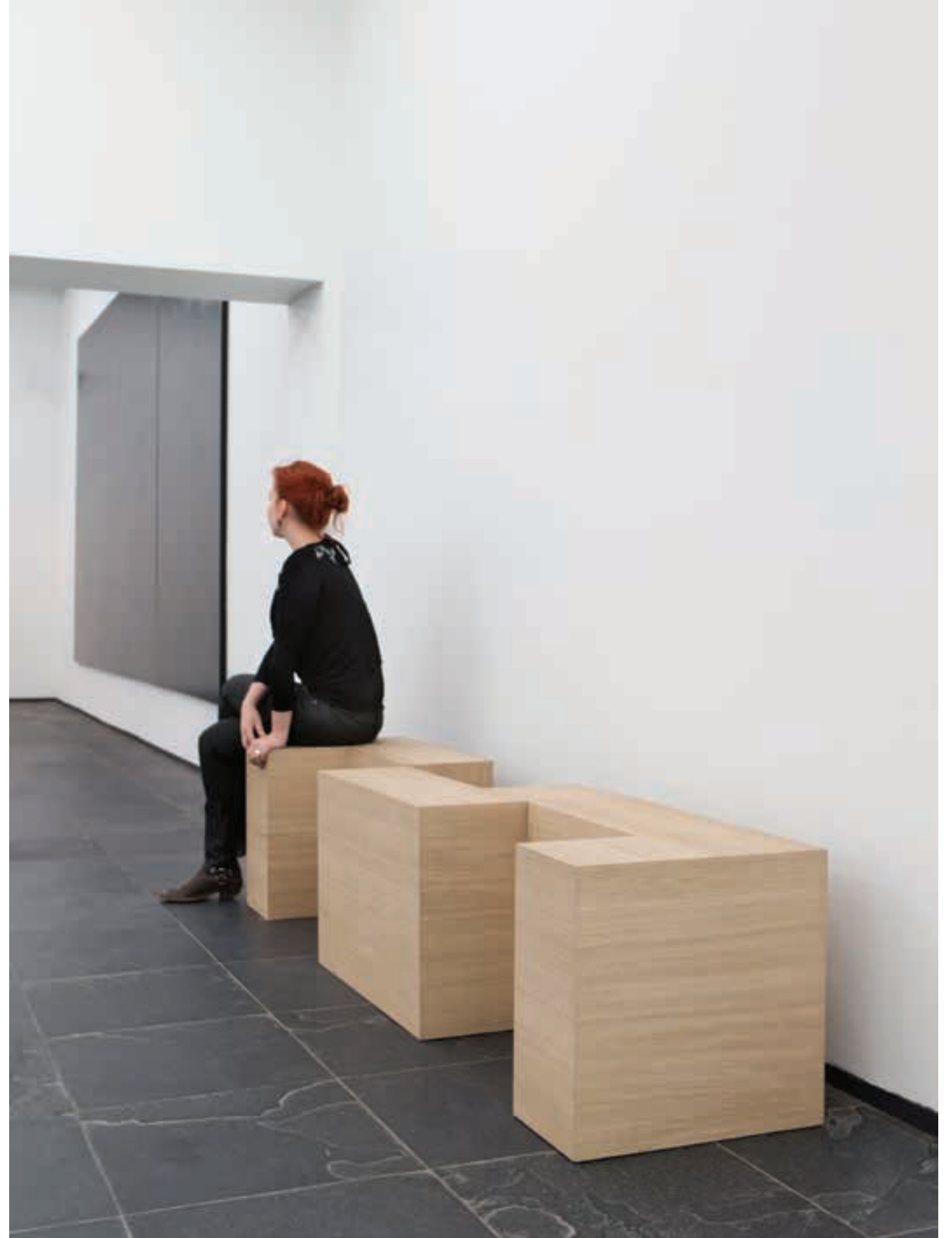

	a	b	h	w
LP60	28cm	65cm	24cm	20kg
LP80	34cm	80cm	32cm	30kg
<i>LP60</i>	<i>11"</i>	<i>25,5"</i>	<i>9,4"</i>	<i>44lbs</i>
<i>LP80</i>	<i>13,8"</i>	<i>31"</i>	<i>12,5"</i>	<i>66lbs</i>

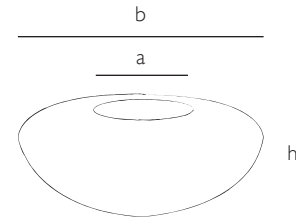

# lp100

T11

	a	b	c	h	w
LP100	56cm	47cm	98cm	57cm	95kg
LPS100	56cm	47cm	98cm	57cm	95kg
<i>LP100</i>	22"	18,5"	38,6"	22,4"	209lbs
<i>LPS100</i>	22"	18,5"	38,6"	22,4"	209lbs

LP has a standard texture  
LPS has the color texture like shown below

Possible finishes:  
Grey clay with black engobe  
Black clay with red engobe  
Black clay with grey engobe  
Black clay with green engobe  
White clay with grey engobe

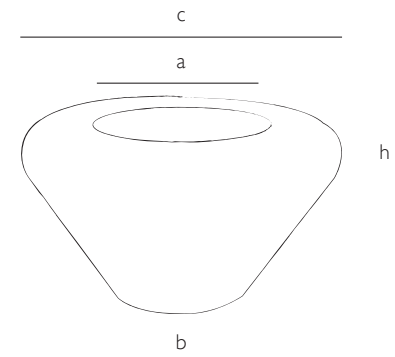

m

	a	b	h	w
M55	35cm	25cm	55cm	25kg
M80*	53cm	29cm	80cm	50kg
M100	68cm	43cm	100cm	80kg
M120	82cm	55cm	120cm	125kg
M55	13,8"	9,8"	21,6"	55lbs
M80*	20,9"	11,4"	31,5"	110lbs
M100	26,8"	16,9"	39,4"	175lbs
M120	32,3"	21,6"	47,2"	275lbs

\* models suitable for a polyester innerliner.

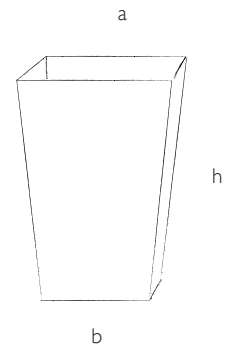



ma

T6

	a	b	h	w
MA80	53cm	29cm	80cm	55kg
MA80	20,9"	11,4"	31,5"	120lbs

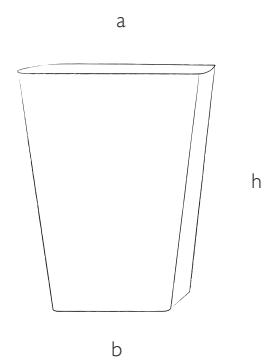



mf

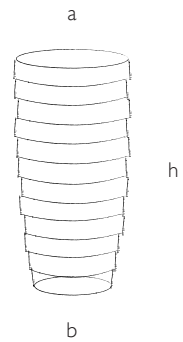

	a	b	h	w
MF100	58cm	38cm	98cm	85kg
MF100	22,8"	15"	38,6"	190lbs



mh

	a	b	h	w
MH80	25cm	20cm	80cm	20kg
MH100*	30cm	23cm	100cm	35kg
MH120*	32cm	23cm	120cm	40kg
MH130*	33cm	23cm	130cm	45kg
<i>MH80</i>	<i>9,8"</i>	<i>7,9"</i>	<i>31,5"</i>	<i>45lbs</i>
<i>MH100*</i>	<i>11,8"</i>	<i>9"</i>	<i>39,4"</i>	<i>77lbs</i>
<i>MH120*</i>	<i>12,6"</i>	<i>9"</i>	<i>47,2"</i>	<i>90lbs</i>
<i>MH130*</i>	<i>12,9"</i>	<i>9"</i>	<i>51,1"</i>	<i>99lbs</i>

\* models suitable for a polyester innerliner.

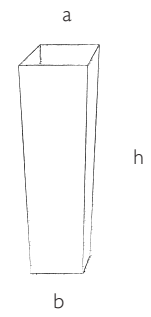

mha100  
mua100

T6

	a	b	h	w
MHA100	30cm	22cm	100cm	35kg
MUA100	49cm	40cm	100cm	70kg
<i>MHA100</i>	<i>11,8"</i>	<i>8,6"</i>	<i>39,4"</i>	<i>77lbs</i>
<i>MUA100</i>	<i>19,3"</i>	<i>15,7"</i>	<i>39,4"</i>	<i>155lbs</i>

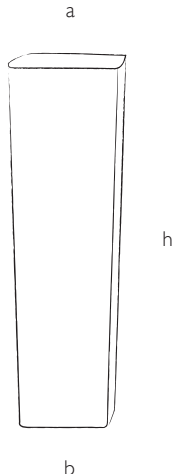

mhr

T13

	a	b	h	w
MHR80	28cm	20cm	80cm	20kg
MHR100*	36cm	28cm	100cm	35kg
MHR120*	36cm	27cm	120cm	40kg
<i>MHR80</i>	<i>11"</i>	<i>7,8"</i>	<i>31,5"</i>	<i>45lbs</i>
<i>MHR100*</i>	<i>14,1"</i>	<i>11"</i>	<i>39,4"</i>	<i>77lbs</i>
<i>MHR120*</i>	<i>14,1"</i>	<i>10,6"</i>	<i>47,2"</i>	<i>88lbs</i>



\* models suitable for a polyester innerliner.

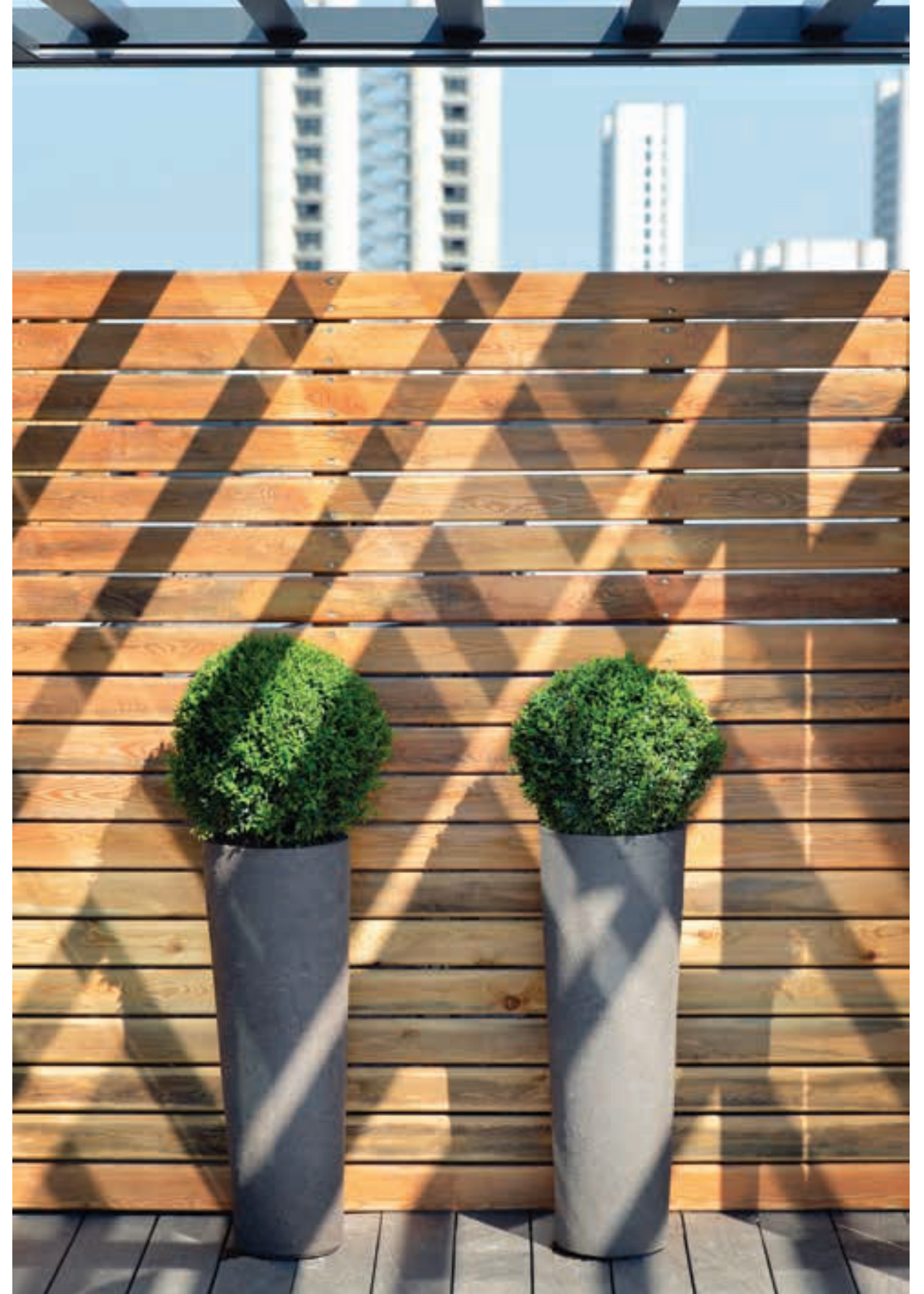

mr

Tz

	a	b	h	w
MR80*	57cm	40cm	76cm	45kg
MR90	80cm	56cm	90cm	100kg
MR130	115cm	85cm	130cm	250kg
MR80*	22,4"	15,7"	29,9"	100lbs
MR90	31,5"	22"	35,4"	220lbs
MR130	45,3"	33,4"	51,2"	550lbs

\* models suitable for a polyester innerliner.

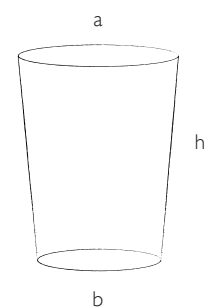

mrr

Tz

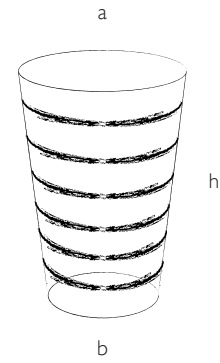

	a	b	h	w
MRR80*	57cm	40cm	76cm	50kg
MRR90	80cm	56cm	90cm	110kg
MRR130	115cm	85cm	130cm	250kg
MRR80*	22,4"	15,7"	29,9"	110lbs
MRR90	31,5"	22"	35,4"	245lbs
MRR130	45,3"	33,5"	51,2"	550lbs

\* models suitable for a polyester innerliner.





mu

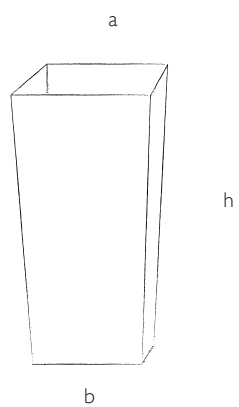

	a	b	h	w
MU80	40cm	29cm	80cm	40kg
MU100	49cm	40cm	100cm	70kg
MU120	52cm	40cm	120cm	85kg
<i>MU80</i>	<i>15,7"</i>	<i>11,4"</i>	<i>31,5"</i>	<i>88lbs</i>
<i>MU100</i>	<i>19,3"</i>	<i>15,7"</i>	<i>39,4"</i>	<i>155lbs</i>
<i>MU120</i>	<i>20,4"</i>	<i>15,7"</i>	<i>47,2"</i>	<i>190lbs</i>

All MU models are suitable for a polyester innerliner.





# mur

	a	b	h	w
MUR80	44cm	32cm	80cm	35kg
MUR100	55cm	40cm	100cm	65kg
MUR120	58cm	45cm	117cm	75kg
<i>MUR80</i>	<i>17,3"</i>	<i>12,6"</i>	<i>31,5"</i>	<i>65lbs</i>
<i>MUR100</i>	<i>21,6"</i>	<i>15,7"</i>	<i>39,4"</i>	<i>145lbs</i>
<i>MUR120</i>	<i>22,8"</i>	<i>17,7"</i>	<i>46"</i>	<i>165lbs</i>

All MUR models are suitable for a polyester innerliner.

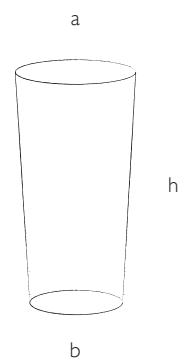

O

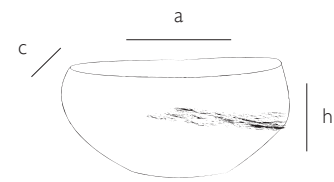

	a	c	h	w
O60	59cm	55cm	30cm	30kg
O75	72cm	69cm	35cm	48kg
O90	86cm	84cm	40cm	60kg
O120	120cm	110cm	64cm	100kg
<i>O60</i>	<i>23,2"</i>	<i>21,6"</i>	<i>11,8"</i>	<i>66lbs</i>
<i>O75</i>	<i>28,3"</i>	<i>27,1"</i>	<i>13,7"</i>	<i>105lbs</i>
<i>O90</i>	<i>33,8"</i>	<i>33"</i>	<i>15,7"</i>	<i>132lbs</i>
<i>O120</i>	<i>47,2"</i>	<i>43,3"</i>	<i>25,2"</i>	<i>220lbs</i>



od

T1

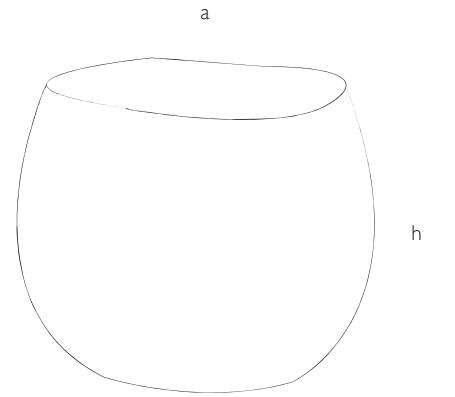

	a	h	w
OD50	50cm	53cm	40kg
OD60	60cm	72cm	60kg
OD60	19,7"	20,9"	88,1lbs
OD60	23,6"	28,3"	132lbs

Possibility with or without color rim.





oe

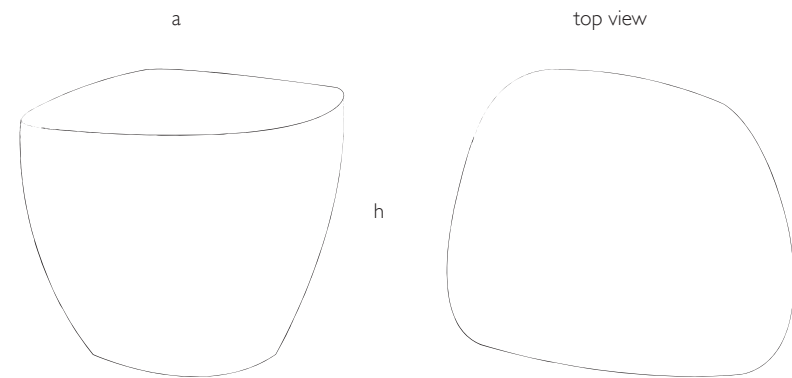

	a	h	w
OE60	56cm	55cm	50kg
OE80	76cm	73cm	100kg
OE60	22"	21,7"	110lbs
OE80	29,9"	28,7"	220lbs



of

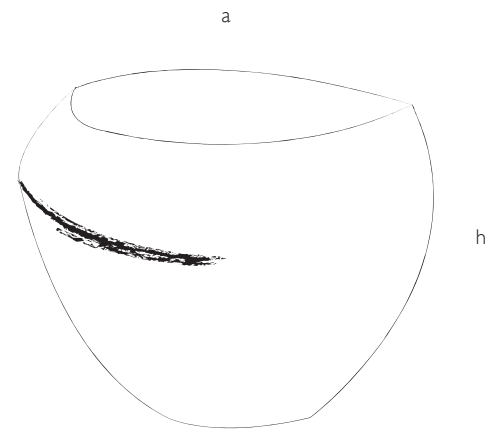

	a	h	w
OF70	70cm	65cm	50kg
OF90	85cm	85cm	100kg
OF70	27,6"	25,6"	110lbs
OF90	33,5"	33,5"	220lbs

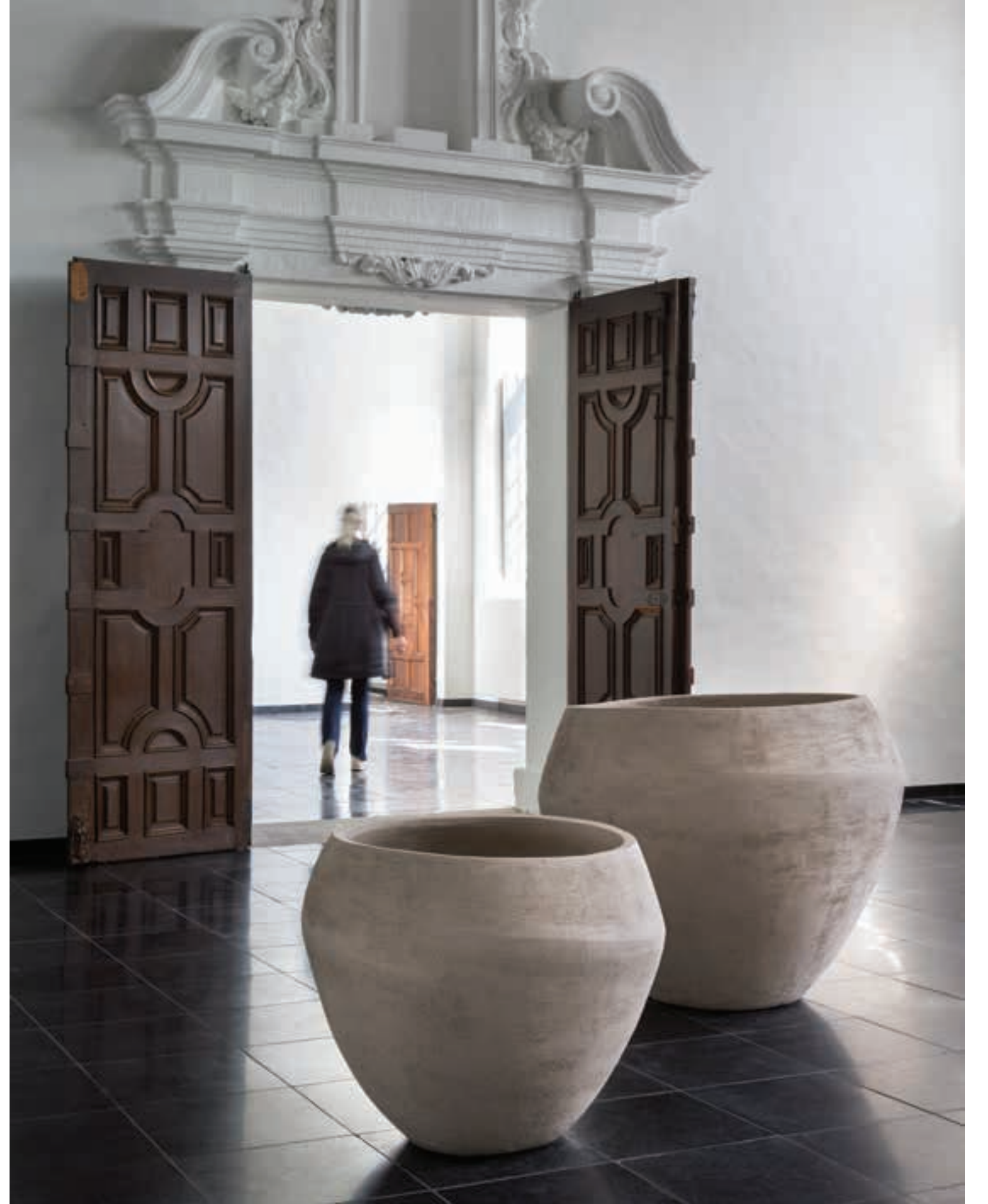

OV

	a	h	w
OV60	55cm	18cm	20kg
OV90	88cm	22cm	35kg
OV60	21,6"	7,1"	45lbs
OV90	34,6"	8,6"	77lbs

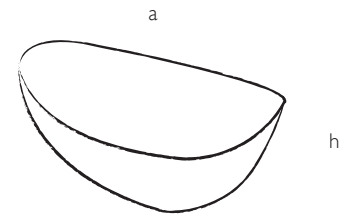





pb

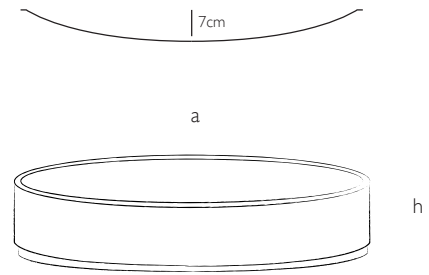

	a	h	w
PB60	60cm	10cm	20kg
PB60	23,6"	3,9"	44lbs

PB is not suitable for outside use during frost.



pl

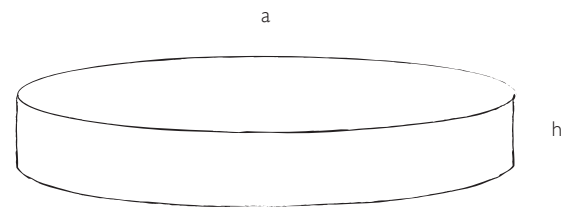

	a	h	w
PL80	80cm	14cm	35kg
PLU80	80cm	14cm	35kg
<i>PL80</i>	<i>31,5"</i>	<i>5,5"</i>	<i>55,1lbs</i>
<i>PLU80</i>	<i>31,5"</i>	<i>5,5"</i>	<i>55,1lbs</i>

PL80 is an open vase  
PLU is a pedestal



rb  
rbc

	a	h	w
RB5060	50cm	60cm	60kg
RBC5060	50cm	60cm	75kg
RB5060	19,7"	23,6"	132lbs
RBC5060	19,7"	23,6"	165lbs

RB is an open vase.  
RBC is a closed pedestal.

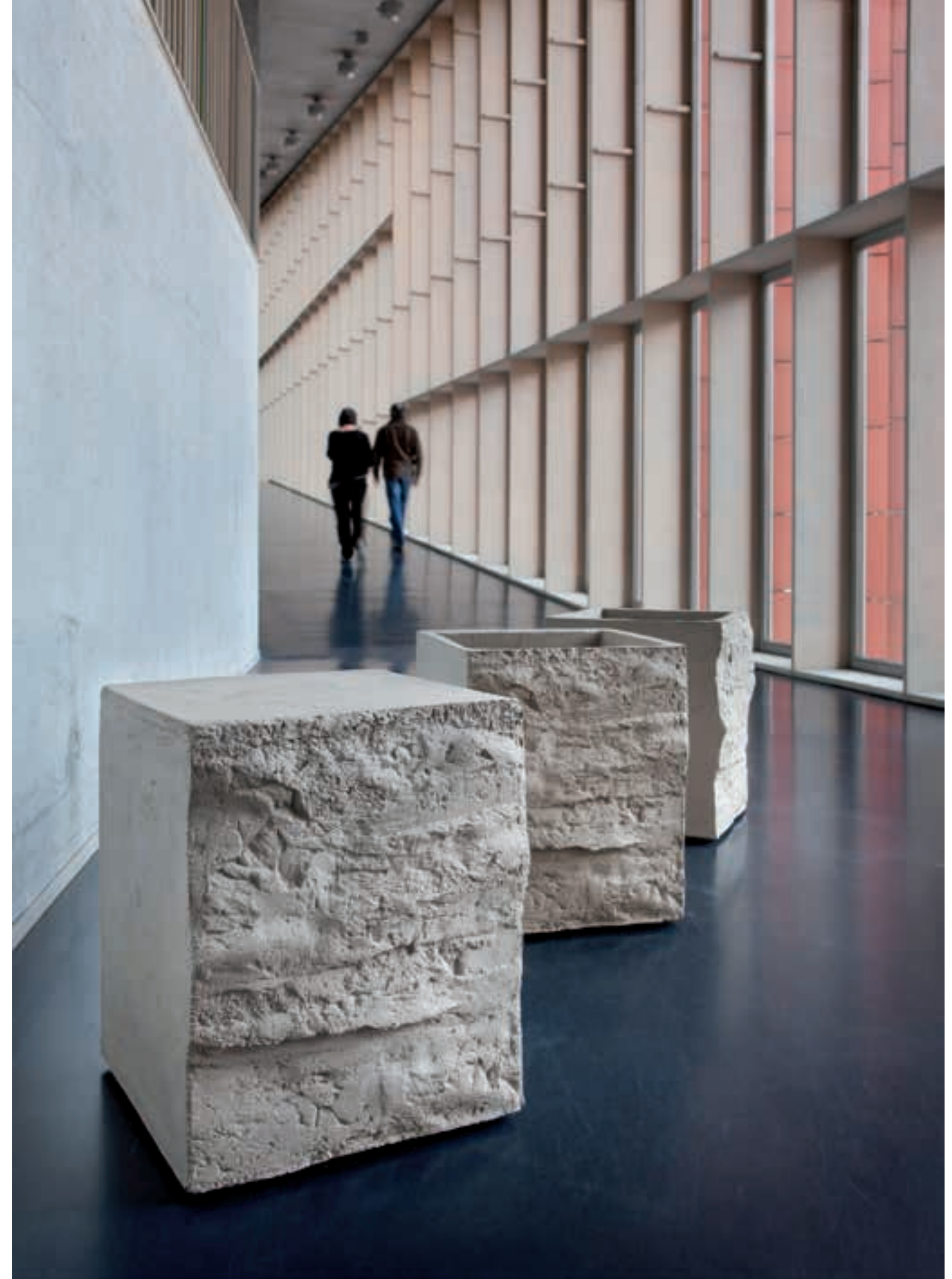
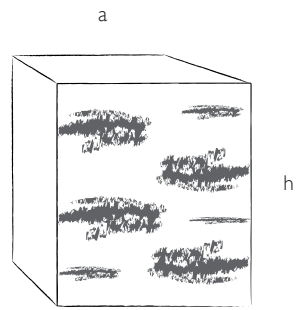

rr

	a	b	h	w
RR55 *	53cm	32cm	45cm	25kg
RR80	75cm	46cm	64cm	50kg
RR100	98cm	58cm	82cm	80kg
RR120	115cm	64cm	95cm	125kg
RR150 *	150cm	90cm	130cm	250kg
RRL55 *	57cm	42cm	26cm	15kg
RR55 *	20,8"	12,6"	17,7"	55lbs
RR80	29,5"	18,1"	25,2"	110lbs
RR100	38,6"	22,8"	32,2"	175lbs
RR120	45,3"	25,2"	37,4"	275lbs
RR150 *	59,1"	35,4"	51,1"	550lbs
RRL55 *	22,4"	16,5"	10,2"	35lbs

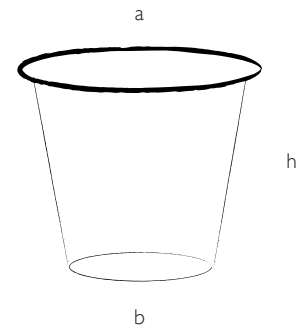

Items with a \* have a sharp rim instead of round as shown on the image below.

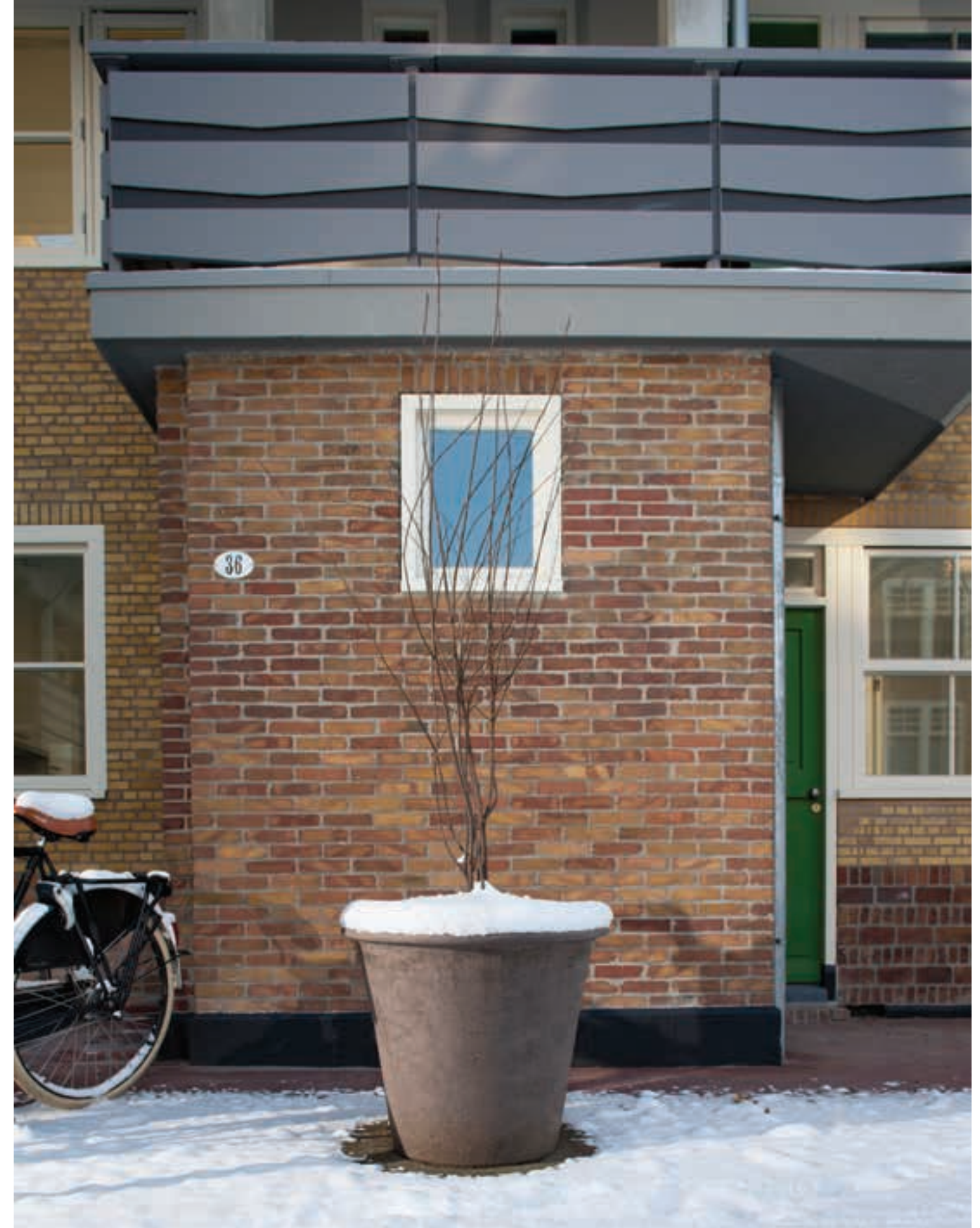

rrh

	a	b	h	w
RRH55 *	43cm	22cm	55cm	20kg
RRH80	64cm	38cm	78cm	50kg
RRH100	83cm	48cm	100cm	85kg
RRH120	100cm	60cm	120cm	125kg
<i>RRH55 *</i>	<i>16,9"</i>	<i>8,6"</i>	<i>21,6"</i>	<i>45lbs</i>
<i>RRH80</i>	<i>25,2"</i>	<i>15"</i>	<i>30,7"</i>	<i>110lbs</i>
<i>RRH100</i>	<i>32,7"</i>	<i>18,9"</i>	<i>39,4"</i>	<i>190lbs</i>
<i>RRH120</i>	<i>39,4"</i>	<i>23,6"</i>	<i>47,2"</i>	<i>275lbs</i>

Items with a \* have a sharp rim instead of round.

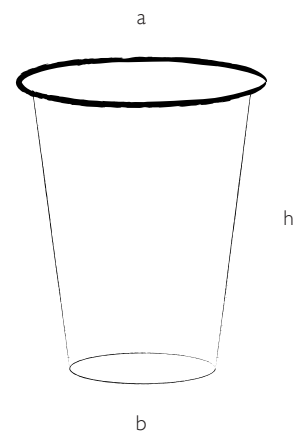

rZ

	a	b	h	w
RZ45	42cm	30cm	45cm	25kg
RZ60	53cm	35cm	60cm	40kg
RZ70	65cm	41cm	70cm	60kg
RZ80	74cm	50cm	80cm	90kg
RZ90	82cm	54cm	90cm	125kg
RZ120	107cm	75cm	120cm	200kg
<i>RZ45</i>	<i>16,5"</i>	<i>11,8"</i>	<i>17,7"</i>	<i>55lbs</i>
<i>RZ60</i>	<i>20,9"</i>	<i>13,8"</i>	<i>23,6"</i>	<i>88lbs</i>
<i>RZ70</i>	<i>25,6"</i>	<i>16,1"</i>	<i>27,5"</i>	<i>135lbs</i>
<i>RZ80</i>	<i>29,1"</i>	<i>19,7"</i>	<i>31,5"</i>	<i>200lbs</i>
<i>RZ90</i>	<i>32,3"</i>	<i>21,2"</i>	<i>35,4"</i>	<i>275lbs</i>
<i>RZ120</i>	<i>42,1"</i>	<i>29,5"</i>	<i>47,2"</i>	<i>440lbs</i>

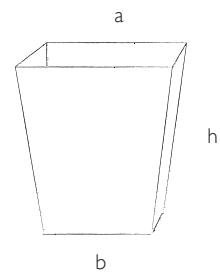

SC

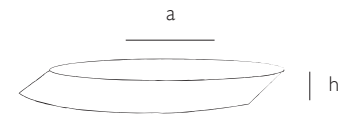

	a	h	w
SC70	70cm	12cm	35kg
SC70	27,5"	4,7"	77lbs



sd

	a	b	h	w
SD90	23cm	26cm	90cm	30kg
SD130	32cm	38cm	130cm	60kg
<i>SD90</i>	<i>9"</i>	<i>10,4"</i>	<i>35,4"</i>	<i>66lbs</i>
<i>SD130</i>	<i>12,6"</i>	<i>15"</i>	<i>51,2"</i>	<i>132lbs</i>

Different line colour combinations are possible.  
Info upon request.  
Not suitable for outside during frost.

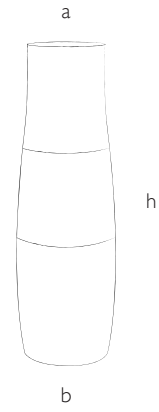



sr  
srd

	a	b	h	w
SR60	50cm	60cm	12cm	20kg
SRD60	50cm	60cm	12cm	25kg
SR75	62cm	75cm	15cm	30kg
SRD75	62cm	75cm	15cm	40kg
SR95	77cm	95cm	19cm	50kg
SRD95	77cm	95cm	19cm	75kg
SR120	100cm	120cm	30cm	125kg
SR60	19,7"	23,6"	4,7"	45lbs
SRD60	19,7"	23,6"	4,7"	55lbs
SR75	24,4"	29,5"	5,9"	65lbs
SRD75	24,4"	29,5"	5,9"	88lbs
SR95	30,3"	37,4"	7,5"	110lbs
SRD95	30,3"	37,4"	7,5"	165lbs
SR120	39,3"	47,2"	11,8"	275lbs

SR is single faced (left).  
SRD is double faced (right).

SR and SRD are not suitable for outside use during frost.

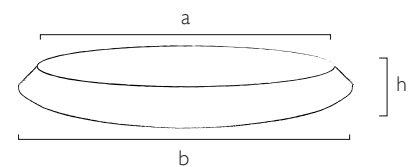



stl  
stb

	a	h	w
STL60	64cm	9cm	15kg
STB60	64cm	9cm	15kg
<i>STL60</i>	25,2"	3,5"	33lbs
<i>STB60</i>	25,2"	3,5"	33lbs

STL and STB are standard delivered with a plexiglass-ring.  
STL and STB are not suitable for outside use during frost.

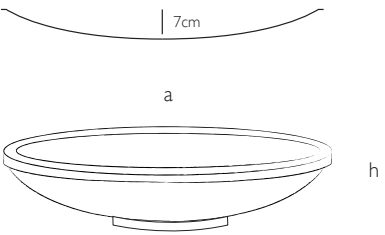

stl



stb



sy  
syd

	a	b	h	w
SY70	40cm	22cm	72cm	40kg
SY90	45cm	26cm	83cm	45kg
SYD90	45cm	26cm	83cm	60kg
SY70	15,7"	8,6"	28,3"	88lbs
SY90	17,7"	10,2"	32,7"	100lbs
SYD90	17,7"	10,2"	32,7"	135lbs

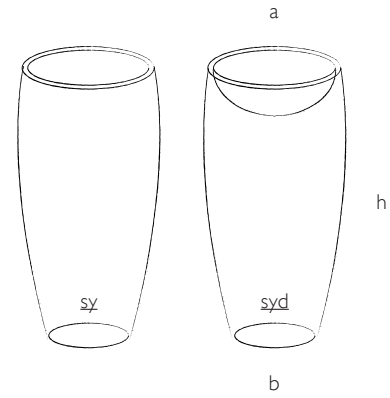

SYD has a bowl inside the pot as shown on the sketch on the right. SYD is not suitable for outside use during frost.



tm

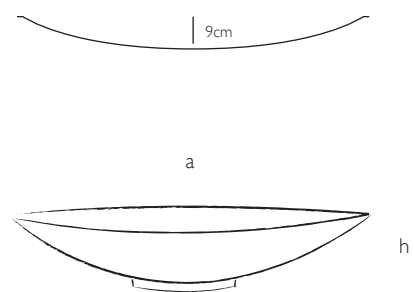

	a	h	w
TM80	82cm	20cm	40kg
TM80	32,3"	7,9"	88lbs

TM80 is not suitable for outside use during frost.



u  
uh

	a	h	w
U40	40cm	30cm	15kg
U50	50cm	39cm	20kg
U60	60cm	48cm	35kg
U70	70cm	50cm	50kg
U80	78cm	60cm	65kg
U100	100cm	72cm	150kg
U120	120cm	90cm	250kg
UH80	48cm	72cm	35kg
<i>U40</i>	<i>15,7"</i>	<i>11,8"</i>	<i>35lbs</i>
<i>U50</i>	<i>19,7"</i>	<i>15,3"</i>	<i>45lbs</i>
<i>U60</i>	<i>23,6"</i>	<i>18,9"</i>	<i>77lbs</i>
<i>U70</i>	<i>27,5"</i>	<i>19,6"</i>	<i>110lbs</i>
<i>U80</i>	<i>30,7"</i>	<i>23,6"</i>	<i>145lbs</i>
<i>U100</i>	<i>39,4"</i>	<i>28,3"</i>	<i>330lbs</i>
<i>U120</i>	<i>47,2"</i>	<i>35,4"</i>	<i>550lbs</i>
<i>UH80</i>	<i>18,9"</i>	<i>38,3"</i>	<i>77lbs</i>

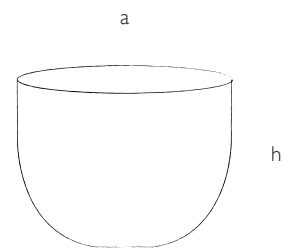

ub

Te

	a	b	h	w
UB40	40cm	20cm	30cm	15kg
UB50	50cm	25cm	39cm	20kg
UB80	78cm	30cm	68cm	75kg
<i>UB40</i>	<i>15,7"</i>	<i>7,9"</i>	<i>11,8"</i>	<i>33lbs</i>
<i>UB50</i>	<i>19,7"</i>	<i>9,8"</i>	<i>15,3"</i>	<i>44lbs</i>
<i>UB80</i>	<i>30,7"</i>	<i>11,8"</i>	<i>26,8"</i>	<i>165lbs</i>

Following bark textures are possible:

- white clay with grey texture
- grey clay with black texture
- black clay with red texture
- red clay with black texture

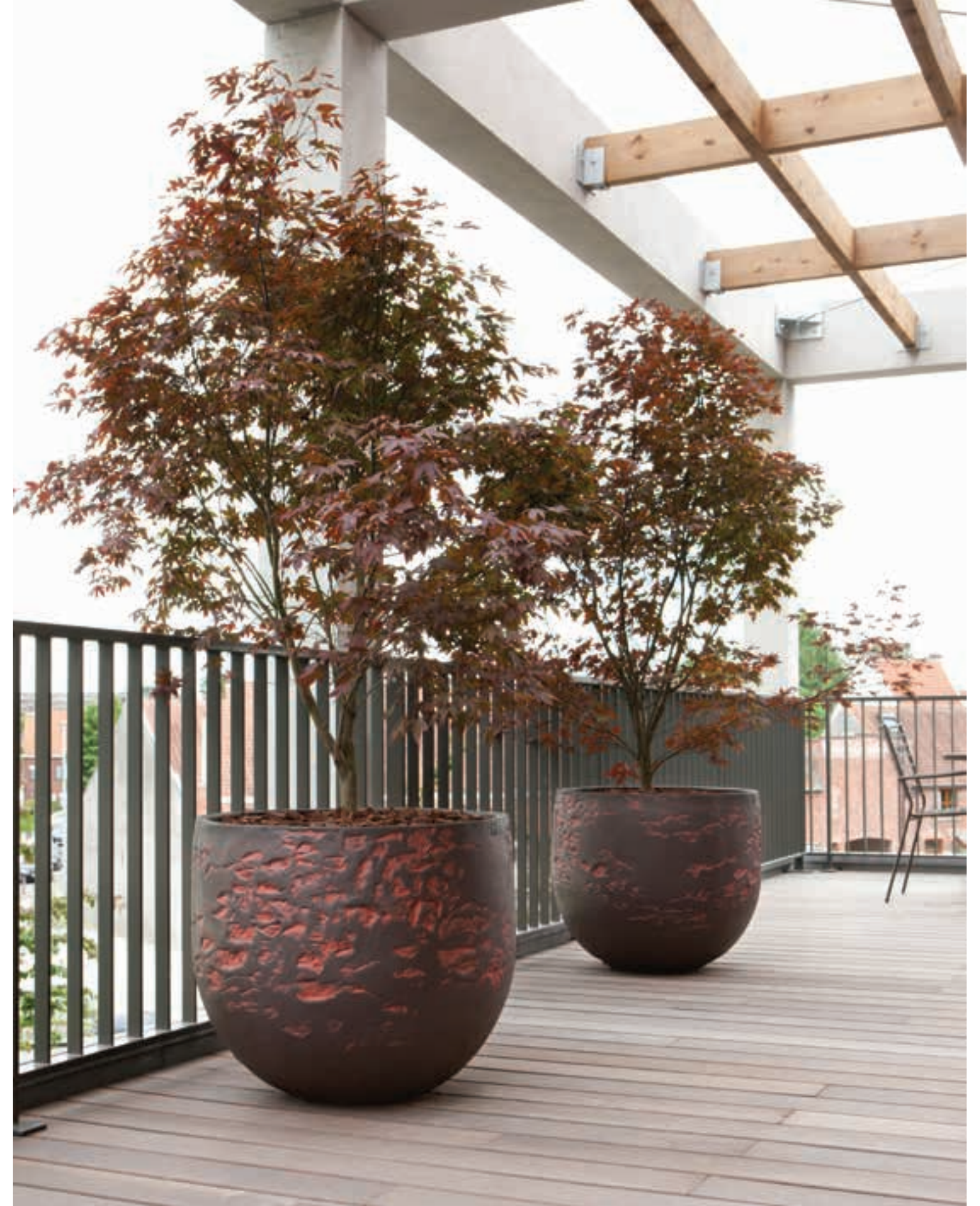
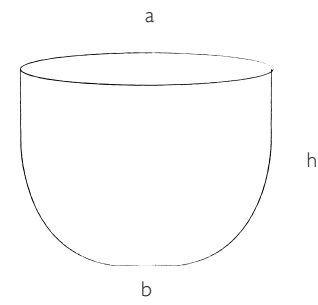

UC

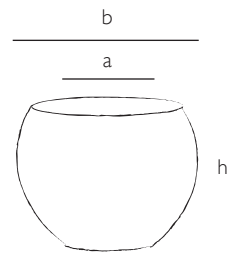

	a	b	h	w
UC50	47cm	57cm	46cm	20kg
UC50	18,5"	22,4"	18,1"	44lbs





ud

	a	h	w
UD30	40cm	28cm	20kg
UD50	60cm	40cm	35kg
UD60	60cm	50cm	40kg
<i>UD30</i>	<i>15,7"</i>	<i>11"</i>	<i>45lbs</i>
<i>UD50</i>	<i>23,6"</i>	<i>15,7"</i>	<i>77lbs</i>
<i>UD60</i>	<i>23,6"</i>	<i>19,7"</i>	<i>88lbs</i>

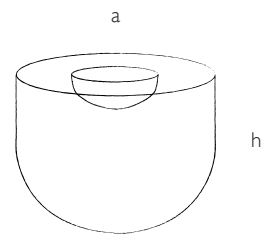

UD is not suitable for outside use during frost



uds

	a	b	h	w
UDS60	30cm	60cm	9cm	20kg
UDS60	11,8"	23,6"	3,9"	44lbs

UDS is not suitable for outside use during frost.

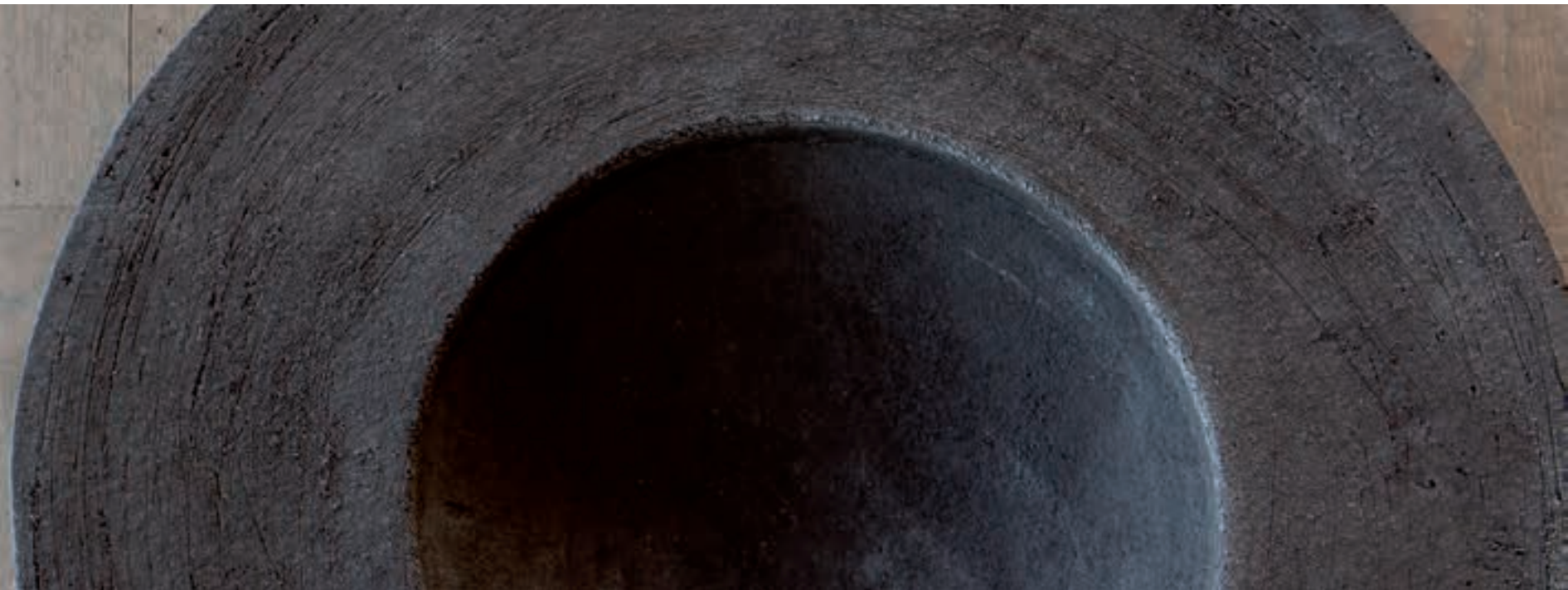
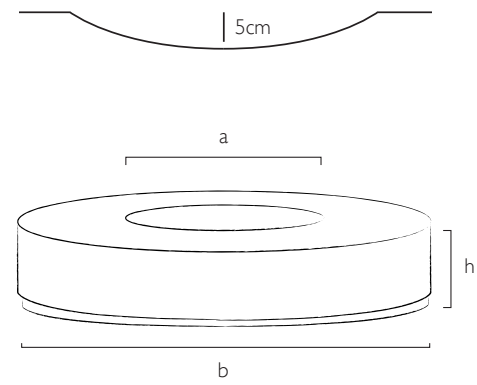

ue

T13



	a	h	w
UE80	78cm	60cm	65kg
UE100	100cm	72cm	150kg
UE120	120cm	90cm	250kg
<i>UE80</i>	<i>30,7"</i>	<i>23,6"</i>	<i>145lbs</i>
<i>UE100</i>	<i>39,4"</i>	<i>28,3"</i>	<i>330lbs</i>
<i>UE120</i>	<i>47,2"</i>	<i>35,4"</i>	<i>550lbs</i>

Possible colour textures are shown on the left.

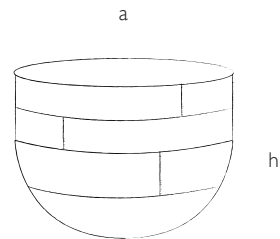



uf

	a	h	w
UF60	58cm	44cm	50kg
UF80	80cm	60cm	80kg
UF100	100cm	72cm	250kg
UF120	120cm	90cm	350kg
UF140	140cm	90cm	400kg
UF160	160cm	96cm	500kg
<i>UF60</i>	<i>22,8"</i>	<i>17,3"</i>	<i>135lbs</i>
<i>UF80</i>	<i>31,5"</i>	<i>23,6"</i>	<i>155lbs</i>
<i>UF100</i>	<i>39,4"</i>	<i>28,3"</i>	<i>330lbs</i>
<i>UF120</i>	<i>47,2"</i>	<i>35,4"</i>	<i>550lbs</i>
<i>UF140</i>	<i>55,1"</i>	<i>35,4"</i>	<i>650lbs</i>
<i>UF160</i>	<i>63"</i>	<i>37,8"</i>	<i>880lbs</i>

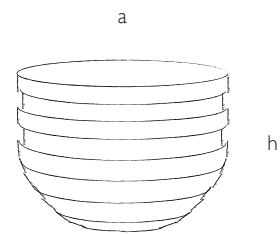



ufs

	a	h	w
UFS40	40cm	9cm	15kg
UFS50	50cm	10cm	20kg
UFS60	60cm	12cm	35kg
UFS80	80cm	15cm	50kg
UFS100	100cm	19cm	75kg
<i>UFS40</i>	<i>15,7"</i>	<i>3,5"</i>	<i>33lbs</i>
<i>UFS50</i>	<i>19,7"</i>	<i>3,9"</i>	<i>44lbs</i>
<i>UFS60</i>	<i>23,6"</i>	<i>4,7"</i>	<i>77lbs</i>
<i>UFS80</i>	<i>31,5"</i>	<i>5,9"</i>	<i>110lbs</i>
<i>UFS100</i>	<i>39,4"</i>	<i>7,5"</i>	<i>165lbs</i>

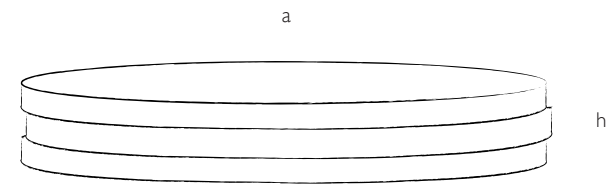

ug

T4

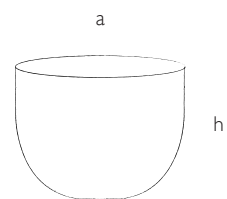

	a	h	w
UG60	60cm	47cm	35kg
UG60	23,6"	18,5"	77lbs





uk



	a	h	w
UK60	60cm	50cm	35kg
UK60	23,6"	19,7"	77lbs

Different colour combinations are possible.  
UK is standard delivered with a plexiglass-ring

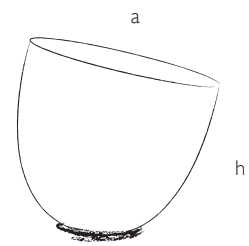

ukl

	a	h	w
UKL60	67cm	22cm	30kg
UKL60	26,4"	8,6"	65lbs

Different colour combinations are possible.  
UKL is standard delivered with a plexiglass-ring

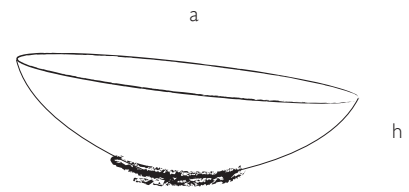



UO

	a	b	h	w
UO80	78cm	30cm	68cm	75kg
UO80	30,7"	11,8"	26,8"	165lbs

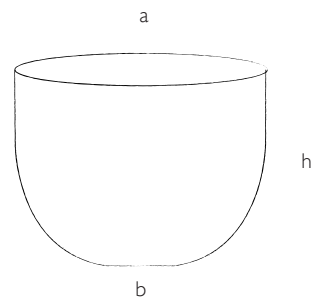

up

T3

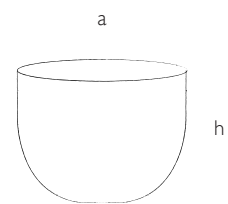

	a	h	w
UP60	60cm	47cm	35kg
UP60	23,6"	18,5"	77lbs

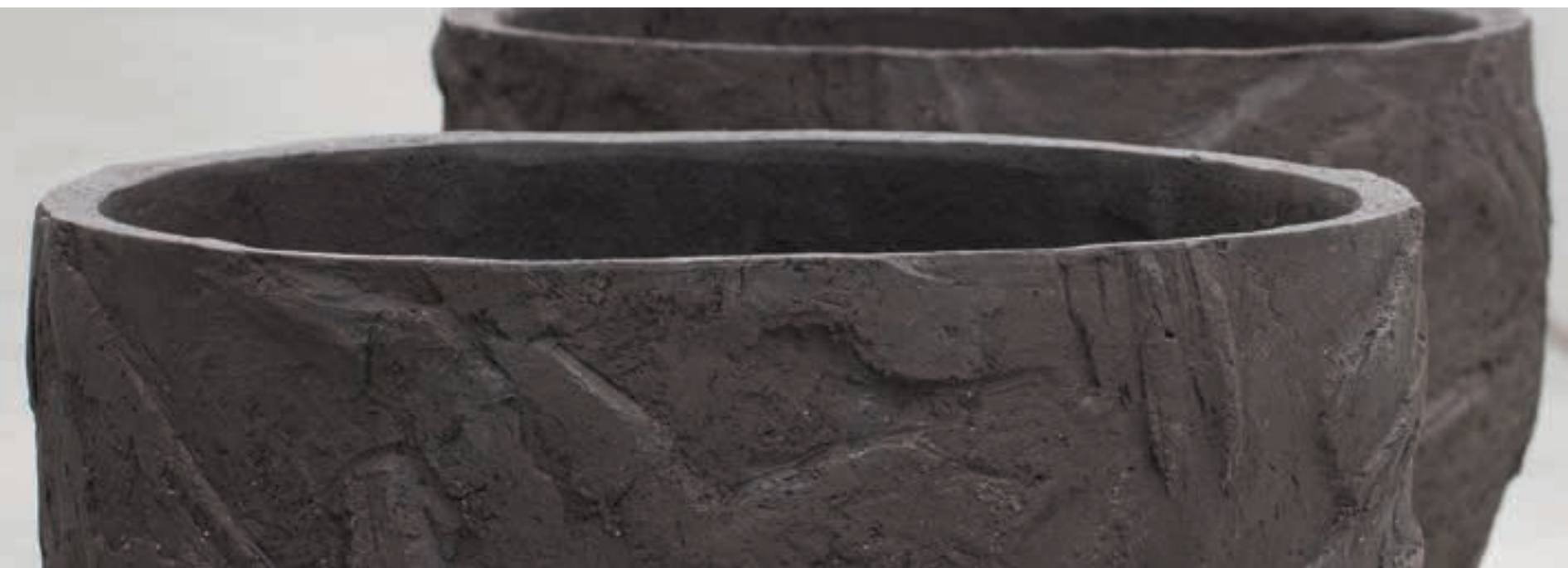

ur

	a	h	w
UR50	60cm	40cm	30kg
UR60	60cm	50cm	35kg
UR80	78cm	60cm	70kg
UR100	100cm	72cm	150kg
UR120	120cm	90cm	250kg
UR50	23,6"	15,7"	55lbs
UR60	23,6"	19,7"	77lbs
UR80	30,7"	23,6"	155lbs
UR100	39,4"	28,3"	330lbs
UR120	47,2"	35,4"	550lbs

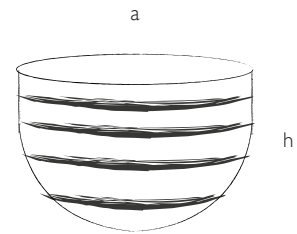



wp

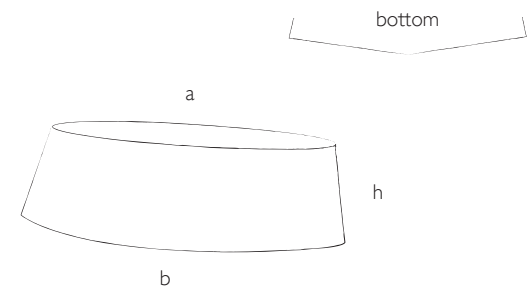

	a	b	h	w
WP60	56cm	62cm	28cm	25kg
WP60	22"	24,4"	11"	55lbs

Different colour combinations are possible.  
Info upon request.





wph

	a	b	h	w
WPH60	52cm	60cm	42cm	35kg
WPH60	20,5"	23,6"	16,5"	77lbs

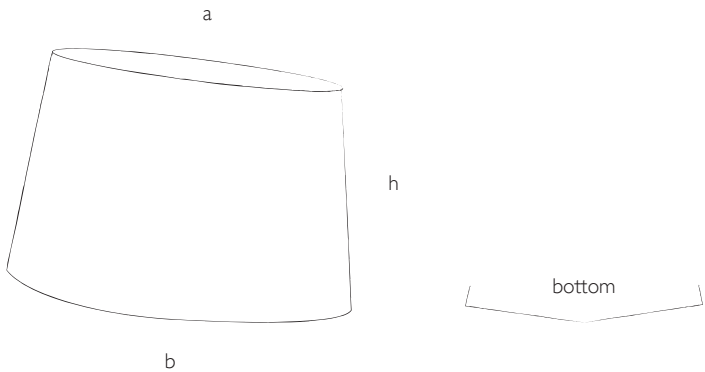

zb

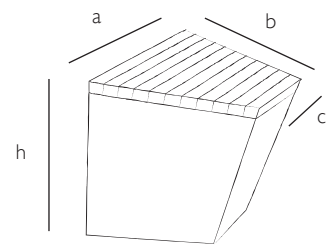

	a	b	c	h	w
ZB50	50cm	39cm	34cm	46cm	30kg
ZB60	53cm	42cm	37cm	51cm	40kg
ZB50	19,6"	15,3"	13,3"	18,1"	66,1lbs
ZB60	20,9"	16,5"	14,6"	20,1"	88,1lbs



ZS

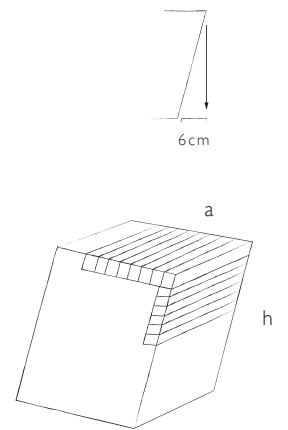

ZS	a	h	w
ZS4555	45cm	54cm	45kg
ZS4070	40cm	69cm	50kg
ZS4555	17,7"	21,3"	99lbs
ZS4070	15,7"	27,2"	110lbs



zsl

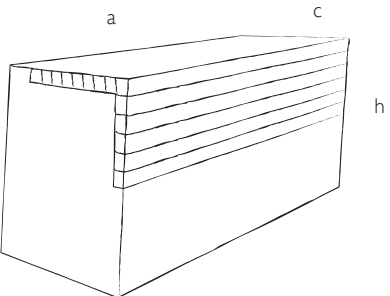

	a	c	h	w
ZSL90	90cm	40cm	45cm	90kg
ZSL90	35,4"	15,7"	17,7"	200lbs



zr  
zrl

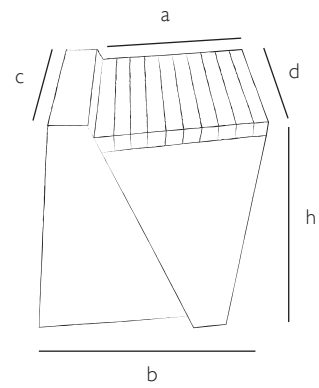

	a	b	c	d	h	w
ZR	36cm	46cm	41cm	45cm	51cm	45kg
ZRL	36cm	46cm	45cm	45cm	51cm	45kg
ZR	14,3"	18,1"	16,1"	17,7"		99lbs
ZRL	14,3"	18,1"	17,7"	17,7"		99lbs

ZR



ZRL



ul

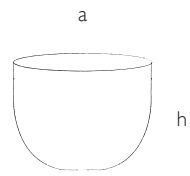

	a	b	h	w
UL40	40cm	20cm	30cm	15kg
UL50	50cm	25cm	39cm	20kg
UL40	15,7"	7,9"	11,8"	35lbs
UL50	19,7"	9,8"	15,3"	45lbs

fp/fpl

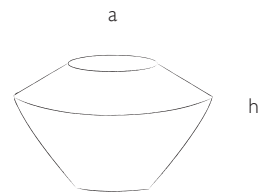

	a	h	w
FP	46cm	29cm	15kg
FPL60	60cm	20cm	20kg
FPL80	80cm	20cm	45kg
FP	18,1"	11,4"	35lbs
FPL60	23,6"	7,9"	45lbs
FPL80	31,5"	7,9"	100lbs

vp

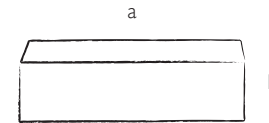

	a	c	h	w
VP1	50cm	17cm	21cm	10kg
VP2	50cm	16cm	21cm	10kg
VP1	19,7"	6,7"	8,2"	22lbs
VP2	19,7"	6,3"	8,2"	22lbs

VP2 is slightly conic.

C

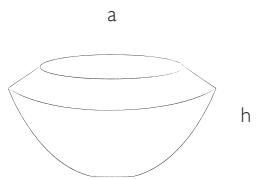

	a	h	w
C	50cm	26cm	15kg
C	19,7"	10,2"	35lbs

at/ate



	a	b	h	w
AT40	28cm	13cm	40cm	15kg
AT50	36cm	17cm	50cm	20kg
ATE40	28cm	13cm	40cm	15kg
ATE50	36cm	17cm	50cm	20kg
AT40	11"	5,1"	15,7"	35lbs
AT50	14,1"	6,7"	19,7"	45lbs
ATE40	11"	5,1"	15,7"	35lbs
ATE50	14,1"	6,7"	19,7"	45lbs

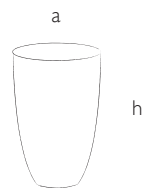

AT40 and AT50 have a natural finish.  
ATE40 and ATE50 have an engobe finish, as shown on the image on the left.

possible colour finishes for ATE:  
white clay with black engobe  
white clay with red engobe  
grey clay with black engobe  
black clay with grey engobe  
black clay with red engobe  
black clay with green engobe

g/gb



	a	b	h	w
G	29cm	42cm	33cm	15kg
GB	29cm	42cm	33cm	15kg
G	11,4"	16,5"	13"	35lbs
GB	11,4"	16,5"	13"	35lbs

GB has a colour texture like shown on the image on the left.

Following bark textures are possible:  
white clay with grey texture  
grey clay with black texture  
black clay with red texture  
red clay with black texture

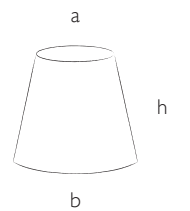

## Applications and maintenance

### Rubber wheels

We offer the possibility to integrate hard rubber wheels in the bottom of the planter. The wheels are fixed to an aluminum capsule and inserted by means of a drilled hole in the bottom of the pot. It enables the customer to place and replace easily the often heavy loaded planter. The insertion of wheels is possible in various types of planters, although a minimum bottom diameter or width of 35cm-40cm / 13'7"-15'7" is required.

### Rubber tap

Make sure that the drainage hole of your planter is kept free at all times, so that excessive water can flow away. We recommend therefore to lift up the planter by means of hard rubber taps with following dimensions: diameter 4 cm and thickness 1 cm. These taps are delivered automatically with each planter.

### Layer of Polystyrene

By putting a layer of polystyrene at the inner side of a parallel straight planter, the lateral pressure caused by frost is reduced and the risk on breakage decreases. Models like B, Bcube, BC, BCH, BM, BP, BR, BRF, BT, BTE, BZ, CL, CLH, CLK, CV, CVI, VP.

### Planters and frost

All planters, shapes and forms in our collection are frost resistant, unless specified. The following items need particular attention, as their closed shape may cause a problem during frost and thaw : BC, BCH, CB, CBH, CBT, CK, DM, DMB, EM, LP, OD, OF, SD, SY, UC, C, G, GB.

### Color consistency

The clay is colored with natural oxides throughout the body, and fired at a temperature of approx 1200° C. The colors obtained by this production process do not fade or deteriorate under influence of the sun.

### Layer of Moisture proof product

The pots are treated with a moisture proof product based on high concentrations of silanes and siloxanes. By reducing moisture absorption the pots are not easily soiled.

### Layer of Polyester

By treating the planters with an extra layer of polyester, the container becomes 100% waterproof. This treatment is recommended for inside use of the planter and on request for all items.

### Polyester inserts

A range of polyester inserts are available for different models. They are fixed at 2cm below the upper rim of the planters by means of a PVC pipe cut off at the required height. They can be used in the following models, as indicated in the main catalog : AH90, AHE90, B5050, BC50, BCH90, BG5050, BG40120, BM40120, BM50100, BR80, BRI00, BRI20, BT-series, BTE-series, BZ-Series, CL60, L1 and L2 Series, M80, MHR100, MHR120, MR80, MRR80, MU-Series, MUR Series.

### Drainage holes

Every item can be provided with or without drainage hole, except for double faced pots (SYD, SRD, UD, DV, DVS, DVH, UDS) and models with inside coloring (UK, UKL, WP) which are used inside. Some applications may require additional or special holes which can be provided if technically possible.

### Saucers

Additional plates to capture drainage water are available in different sizes. Due to technical limits and weight restrictions, the size of the plates is limited to a maximum of diameter 60cm/23'6" or 60x60/ 23'6" x 23'6".

### Anti-green

All following products received a standard treatment with an invisible liquid and mat silicone B –Artisil : KE, KR, KD, KL, KKA, KKB, KKC, LC. Other products can have a treatment on demand.

### Custom works

Some of your projects may require a particular shape, a special form that goes beyond the lines of our standard collection. Architects are welcome in our atelier to discuss the design for a particular project, to develop the right form and to finalize the prototype into the required shape. Proposals are screened on their technical feasibility, and on their esthetical appearance. Custom designs tend to start from the standard collection, to adapt certain measures and proportions or to change the texture of the planter.

### Roulettes en caoutchouc

Nous offrons la possibilité d'intégrer des roulettes en caoutchouc durci dans le fond de la jardinière. Elles sont fixées à une capsule en aluminium et insérées dans un trou foré dans le fond du pot. Cette solution permet au client de mettre et remettre aisément en place des jardinières souvent lourdement chargées. Le montage des roues est possible sur différents modèles de jardinières pour autant que le fond présente un diamètre ou une largeur de 35 cm-40 cm / 13'7"-15'7" minimum.

### Rondelles en caoutchouc

Veillez à ce que l'orifice de drainage de votre jardinière soit toujours dégagé afin que l'excédent d'eau puisse s'en écouler. Nous recommandons dès lors de surélever la jardinière au moyen de rondelles en caoutchouc durci ayant les dimensions suivantes : 4 cm de diamètre sur 1 cm d'épaisseur. Ces rondelles sont fournies de série avec chaque jardinière.

### Couche de polystyrène

En appliquant une couche de polystyrène sur la face interne d'une jardinière droite parallèle, la pression latérale due au gel et le risque de la voir se fendre sont réduits. Modèles de type B, Bcube, BC, BCH, BM, BP, BR, BRf, BT, BTE, BZ, CL, CLH, CLK, CV, CVI, VP.

### Les jardinières et le gel

Sauf indications contraires, toutes les jardinières et les formes composant notre assortiment sont résistantes au gel. Les modèles suivants requièrent une attention particulière dès lors que leur forme fermée peut causer problème en cas de gel et de dégel : BC, BCH, CB, CBH, CBT, CK, DM, DMB, EM, LP, OD, OF, SD, SY, UC, C, G, GB.

### Uniformité des couleurs

L'argile est colorée dans la masse au moyen d'oxydes naturels, puis cuite à une température approximative de 1200°C. Les coloris obtenus lors de ce processus de production ne se décolorent pas et ne se dégradent pas sous l'action du soleil.

### Couche de silicone

Tous nos articles sont traités de série par l'application d'une couche interne de silicone destinée à éviter la pénétration du calcium ou du sel.

### Couche de polyester

Grâce à la couche de polyester supplémentaire qui recouvre les jardinières, ces dernières sont imperméabilisées à 100 %. Ce traitement est recommandé si la jardinière est destinée à être utilisée à l'intérieur et peut être appliqué à la demande sur tous nos articles.

### Inserts en polyester

Une série d'inserts en polyester peuvent équiper différents modèles. Ils se fixent 2 cm sous le niveau de la bague supérieure des jardinières, à l'aide d'un tuyau de PVC découpé à la hauteur appropriée. Ils peuvent être utilisés sur les modèles suivants, comme indiqué dans notre catalogue général : AH90, AHE90, B5050, BC50, BCH90, BG5050, BG40120, BM40120, BM50100, BR80, BRI00, BRI20, série BT, série BTE, série BZ, CL60, séries LI et L2, M80, MHR100, MHRI20, MR80, MRR80, série MU, série MUR.

### Orifices de drainage

Chaque article peut être livré avec ou sans orifice de drainage, excepté les pots double face (SYD, SRD, UD, DV, DVS, DVH, UDS) ainsi que les modèles à face interne colorée (UK, UKL, WP) qui sont utilisés à l'intérieur. Il se peut que certaines applications nécessitent des orifices spéciaux ou additionnels. Nous les réalisons si cela est techniquement possible.

### Sous-jardinières

Des plateaux de différentes tailles, destinés à recueillir l'eau de drainage, sont disponibles en option. En raison des limitations techniques et des restrictions de poids, les dimensions de ces sous-jardinières sont limitées à un diamètre maximal de 60 cm/23'6" ou à une section de 60x60/ 23'6" x 23'6".

### Traitement anti-verdissement

Les produits suivants ont reçu de série un traitement invisible à la silicone liquide mate (B –Artisil) : KE, KR, KD, KL, KKA, KKB, KKC, LC. D'autres produits peuvent également en bénéficier sur demande.

### Travaux sur mesure

Il se peut que certains de vos projets nécessitent une forme particulière, un dessin spécial, qui sorte du cadre de notre assortiment courant. Les architectes sont les bienvenus dans notre atelier pour discuter de la conception d'un projet donné, élaborer la forme appropriée et mettre la dernière main à la configuration du prototype. La faisabilité technique des propositions et leur aspect esthétique seront passés au crible. Dans le domaine du sur-mesure, la tendance est de prendre l'assortiment courant comme point de départ et d'en adapter certaines cotes et proportions ou de modifier la texture de la jardinière.



## Anwendungen und Pflege

### **Gummirädchen**

Wir bieten die Möglichkeit, Hartgummirädchen an der Unterseite des Pflanzgefäßes anzubringen. Die Rädchen werden an einer Aluminiumkapsel befestigt und über ein gebohrtes Loch in der Unterseite des Topfes eingeführt. So kann der Kunde das häufig schwer beladene Pflanzgefäß mühelos aufstellen und bewegen. Die Rädchen können in verschiedene Pflanzgefäßtypen eingeführt werden, jedoch ist an der Unterseite ein Durchmesser bzw. eine Breite von mindestens 35-40 cm erforderlich.

### **Gummifüßchen**

Stellen Sie sicher, dass das Abflussloch Ihres Pflanzgefäßes jederzeit frei ist, so dass überschüssiges Wasser abfließen kann. Zu diesem Zweck empfehlen wir, das Pflanzgefäß mittels Hartgummifüßchen, die einen Durchmesser von 4 cm und eine Dicke von 1 cm aufweisen, etwas anzuheben. Diese Füßchen werden mit jedem Pflanzgefäß mitgeliefert.

### **Polystyrolschicht**

Dank einer Polystyrolschicht an der Innenseite des parallelen geraden Pflanzgefäßes wird der seitliche Druck durch Frost und damit das Bruchrisiko verringert. Modelle wie z.B. B, Bcube, BC, BCH, BM, BP, BR, BRF, BT, BTE, BZ, CL ,CLH, CLK, CV, CVI, VP.

### **Pflanzgefäße und Frost**

Sämtliche Pflanzgefäße, Formen und Ausprägungen in unserer Kollektion sind, sofern keine anderslautenden Angaben enthalten sind, frostbeständig. Folgende Artikel erfordern besondere Aufmerksamkeit, da ihre geschlossene Form bei Frost und Tauwetter zu Problemen führen kann: BC, BCH, CB, CBH, CBT, CK, DM, DMB, EM, LP, OD, OF, SD, SY, UC, C, G, GB.

### **Farbbeständigkeit**

Der Lehm wird mit natürlichen Oxiden durchgängig gefärbt und bei ca. 1200 °C gebrannt. Die in diesem Herstellungsprozess erzielten Farbtöne bleichen nicht aus und verblassen nicht unter Sonneneinwirkung.

### **Silikonschicht**

Sämtliche Artikel werden standardmäßig auf der Innenseite mit einer Silikonschicht versehen, um den Eintritt von Kalk oder Salz zu verhindern.

### **Polyesterschicht**

Eine zusätzliche Polyesterbeschichtung macht die Pflanzgefäße zu 100 % wasserdicht. Diese Behandlung wird für Pflanzgefäße im Innenbereich empfohlen und auf Wunsch für alle Artikel durchgeführt.

### **Polyestereinsätze**

Für die verschiedenen Modelle steht eine breite Palette an Polyestereinsätzen zur Verfügung. Sie werden mit einem PVC-Rohr, das an der benötigten Höhe abgetrennt wird, 2 cm unter der Oberkante der Pflanzgefäße befestigt. Sie können in den folgenden Modellen eingesetzt werden (siehe Angaben im Hauptkatalog): AH90, AHE90, B5050, BC50, BCH90, BG5050, BG40120, BM40120, BM50100, BR80, BRI00, BRI20, BT-Serie, BTE-Serie, BZ-Serie, CL60, Serien LI und L2, M80, MHR100, MHR120, MR80, MRR80, MU-Serie, MUR-Serie.

### **Abflusslöcher**

Jeder Artikel kann mit oder ohne Abflussloch gewählt werden, mit Ausnahme von zweiseitigen Töpfen (SYD, SRD, UD, DV, DVS, DVH, UDS) und Modellen mit Farbbeschichtung innen (UK, UKL, WP), die im Innenbereich verwendet werden. Für manche Anwendungen werden ggf. zusätzliche oder spezielle Löcher benötigt, die hergestellt werden können, sofern dies technisch möglich ist.

### **Untersetzer**

Zusätzliche Untersetzer zum Auffangen von abfließendem Wasser sind in verschiedenen Größen erhältlich. Aufgrund von technischen Beschränkungen und Gewichtsgrenzen ist die Größe der Untersetzer auf einen Durchmesser von maximal 60 cm bzw. eine Fläche von 60x60 cm begrenzt.

### **Grünbelagentferner**

Folgende Produkte wurden standardmäßig mit einer rückstandsfreien Flüssigkeit und mattem Silikon B - Artisil behandelt: KE, KR, KD, KL, KKA, KKB, KKC, LC. Weitere Produkte können auf Wunsch behandelt werden.

### **Maßgeschneiderte Produkte**

Für einige Ihrer Projekte benötigen Sie gegebenenfalls eine besondere Form oder eine spezielle Gestalt, die über die Linien unserer Standardkollektion hinausgeht. Gerne besprechen wir mit Architekten in unseren Räumlichkeiten den Plan für ein bestimmtes Projekt, um die richtige Form zu entwickeln und den Prototyp auszuarbeiten. Vorschläge werden auf ihre technische Machbarkeit und ihren ästhetischen Gesamteindruck geprüft. Maßgeschneiderte Lösungen gehen meist von der Standardkollektion aus, wobei manche Abmessungen und Proportionen angepasst oder die Textur des Pflanzgefäßes verändert werden.

## Aplicaciones y mantenimiento

### Ruedas de caucho

Ofrecemos la posibilidad de integrar ruedas de ebonita en el fondo del plantador. Las ruedas se fijan a una cápsula de aluminio y se insertan por medio de un agujero taladrado en el fondo de la maceta. Esto permite al cliente colocar y volver a colocar fácilmente el plantador cargado a menudo con mucho peso. La inserción de ruedas es posible en varios tipos de plantadores, pero se requiere una anchura o diámetro mínimo del fondo de 35 cm - 40 cm / 13'7" - 15'7".

### Canilla de caucho

Asegúrese de que el agujero de drenaje del plantador esté siempre libre de obstáculos, de modo que pueda derramarse el exceso de agua. Recomendamos, por lo tanto, levantar el plantador mediante canillas de ebonita de las siguientes dimensiones: 4 cm de diámetro y 1 cm de grosor. Estas canillas se entregan automáticamente con cada plantador.

### Capa de poliestireno

Poniendo una capa de poliestireno en el lado interior del plantador recto paralelo, la presión lateral causada por la helada se reduce y el riesgo de rotura disminuye. Modelos como B, Bcube, BC, BCH, BM, BP, BR, BRF, BT, BTE, BZ, CL ,CLH, CLK, CV, CVI, VP.

### Los plantadores y las heladas

Todos los plantadores, configuraciones y formas de nuestra colección son resistente a las heladas, a menos que se especifique lo contrario. Los siguientes artículos requieren una especial atención, ya que su forma cerrada puede provocar problemas durante la helada y el deshielo: BC, BCH, CB, CBH, CBT, CK, DM, DMB, EM, LP, OD, OF, SD, SY, UC, C, G, GB.

### Consistencia del color

La arcilla ha sido coloreada con óxidos naturales en todo el cuerpo y cocida a una temperatura de unos 1200° C. Los colores obtenidos con este proceso de producción no desaparecen ni se deterioran bajo la influencia del sol.

### Capa de silicona

Todos los artículos son tratados como estándar con una capa interior de silicona para evitar la penetración de sal o calcio.

### Capa de poliéster

Al tratar los plantadores con una capa adicional de poliéster, el contenedor se convierte en 100% impermeable al agua. Este tratamiento se recomienda para su uso dentro del plantador y, a petición, de todos los artículos.

### Insertos de poliéster

Se dispone de varios insertos de poliéster para diferentes modelos. Se fijan a 2 cm por debajo del borde superior de los plantadores por medio de un tubo de PVC cortado a la altura requerida. Se pueden utilizar en los siguientes modelos, tal como se indica en el catálogo principal: AH90, AHE90, B5050, BC50, BCH90, BG5050, BG40120, BM40120, BM50100, BR80, BRI00, BRI20, serie BT, serie BTE, serie BZ, CL60, series LI y L2, M80, MHR100, MHRI20, MR80, MRR80, serie MU, serie MUR.

### Orificios de drenaje

Cada artículo puede estar provisto con o sin el orificio de drenaje, excepto las macetas de doble cara SYD, SRD, UD, DV, DVS, DVH, UDS) y los modelos con coloreado interior (UK, UKL, WP) que se usan en interior.

Algunas aplicaciones pueden requerir orificios adicionales o especiales que pueden proporcionarse si es técnicamente posible.

### Platillos

Se dispone de platos adicionales para capturar el agua de drenaje en los siguientes tamaños. Debido a las limitaciones técnicas y a las restricciones de peso, el tamaño de los platos está limitado a un máximo de 60cm/23'6" o 60x60/ 23'6" x 23'6" de diámetro.

### Anti-verde

Los siguientes productos recibieron un tratamiento estándar con una silicona mate y líquida invisible B -Artisil: KE, KR, KD, KL, KKA, KKB, KKC, LC. Se puede aplicar el tratamiento a otros productos a petición.

### Trabajos de encargo

Algunos de los proyectos pueden requerir una forma particular, una forma especial que va más allá de las líneas de nuestra colección estándar. Damos la bienvenida a los arquitectos en nuestro taller para hablar del diseño para un proyecto en particular, desarrollar la forma correcta y finalizar el prototipo en la forma requerida. Las ofertas son seleccionadas en su viabilidad técnica y en su aspecto estético. Los diseños de encargo tienden a iniciarse a partir de la colección estándar, para adaptar ciertas medidas y proporciones o para cambiar la textura del plantador.

## Applicazioni e mantenimento

### Ruedas de caucho

Ofrecemos la posibilidad de integrar ruedas de ebonita en el fondo del plantador. Las ruedas se fijan a una cápsula de aluminio y se insertan por medio de un agujero taladrado en el fondo de la maceta. Esto permite al cliente colocar y volver a colocar fácilmente el plantador cargado a menudo con mucho peso. La inserción de ruedas es posible en varios tipos de plantadores, pero se requiere una anchura o diámetro mínimo del fondo de 35 cm - 40 cm / 13'7" - 15'7".

### Canilla de caucho

Asegúrese de que el agujero de drenaje del plantador esté siempre libre de obstáculos, de modo que pueda derramarse el exceso de agua. Recomendamos, por lo tanto, levantar el plantador mediante canillas de ebonita de las siguientes dimensiones: 4 cm de diámetro y 1 cm de grosor. Estas canillas se entregan automáticamente con cada plantador.

### Capa de poliestireno

Poniendo una capa de poliestireno en el lado interior del plantador recto paralelo, la presión lateral causada por la helada se reduce y el riesgo de rotura disminuye. Modelos como B, Bcube, BC, BCH, BM, BP, BR, BRF, BT, BTE, BZ, CL ,CLH, CLK, CV, CVI, VP.

### Los plantadores y las heladas

Todos los plantadores, configuraciones y formas de nuestra colección son resistente a las heladas, a menos que se especifique lo contrario. Los siguientes artículos requieren una especial atención, ya que su forma cerrada puede provocar problemas durante la helada y el deshielo: BC, BCH, CB, CBH, CBT, CK, DM, DMB, EM, LP, OD, OF, SD, SY, UC, C, G, GB.

### Consistencia del color

La arcilla ha sido coloreada con óxidos naturales en todo el cuerpo y cocida a una temperatura de unos 1200° C. Los colores obtenidos con este proceso de producción no desaparecen ni se deterioran bajo la influencia del sol.

### Capa de silicona

Todos los artículos son tratados como estándar con una capa interior de silicona para evitar la penetración de sal o calcio.

### Capa de poliéster

Al tratar los plantadores con una capa adicional de poliéster, el contenedor se convierte en 100% impermeable al agua. Este tratamiento se recomienda para su uso dentro del plantador y, a petición, de todos los artículos.

### Insertos de poliéster

Se dispone de varios insertos de poliéster para diferentes modelos. Se fijan a 2 cm por debajo del borde superior de los plantadores por medio de un tubo de PVC cortado a la altura requerida. Se pueden utilizar en los siguientes modelos, tal como se indica en el catálogo principal: AH90, AHE90, B5050, BC50, BCH90, BG5050, BG40120, BM40120, BM50100, BR80, BRI00, BRI20, serie BT, serie BTE, serie BZ, CL60, series LI y L2, M80, MHR100, MHR120, MR80, MRR80, serie MU, serie MUR.

### Orificios de drenaje

Cada artículo puede estar provisto con o sin el orificio de drenaje, excepto las macetas de doble cara SYD, SRD, UD, DV, DVS, DVH, UDS) y los modelos con coloreado interior (UK, UKL, WP) que se usan en interior.

Algunas aplicaciones pueden requerir orificios adicionales o especiales que pueden proporcionarse si es técnicamente posible.

### Platillos

Se dispone de platos adicionales para capturar el agua de drenaje en los siguientes tamaños. Debido a las limitaciones técnicas y a las restricciones de peso, el tamaño de los platos está limitado a un máximo de 60cm/23'6" o 60x60/ 23'6" x 23'6" de diámetro.

### Anti-verde

Los siguientes productos recibieron un tratamiento estándar con una silicona mate y líquida invisible B -Artisil: KE, KR, KD, KL, KKA, KKB, KKC, LC. Se puede aplicar el tratamiento a otros productos a petición.

### Trabajos de encargo

Algunos de los proyectos pueden requerir una forma particular, una forma especial que va más allá de las líneas de nuestra colección estándar. Damos la bienvenida a los arquitectos en nuestro taller para hablar del diseño para un proyecto en particular, desarrollar la forma correcta y finalizar el prototipo en la forma requerida. Las ofertas son seleccionadas en su viabilidad técnica y en su aspecto estético. Los diseños de encargo tienden a iniciarse a partir de la colección estándar, para adaptar ciertas medidas y proporciones o para cambiar la textura del plantador.